

PRODUCT DATA SHEET



PRODUCT CODE

CASFBC1000

RANGE

Clear 6

DESCRIPTION

Clear 6 Side Panel 1000 Brushed Brass

WEBSITE LINK [Click Here](#)

CATEGORY	Showering
WARRANTY DETAILS	Lifetime
COLOUR	Brushed Brass
FINISH APPLICATION	Anodised
PRIMARY MATERIAL	Glass
INSTALL TYPE	Wall Mounted
PRODUCT WIDTH MM	975
PRODUCT HEIGHT MM	1950
PRODUCT NET WEIGHT KG	31
STANDARDS	EN14428

HANDING SHOWERING	Universal
GLASS THICKNESS	6mm
EASY CLEAN	Yes
MAGNETIC DOOR STRIPS	No
POWER SHOWER PROOF	Yes
NUMBER OF DOORS	1
SOFT CLOSING DOORS	No
SAFETY GLASS	Yes
REMOVABLE SEALS	No
QUICK RELEASE ROLLERS	No
WET ROOM COMPATIBLE	Yes
DOOR A INFORMATION	Side panel
DOOR ADJUSTMENT	975-990mm

TECHNICAL DIMENSIONS

Dimensions in mm unless otherwise specified.

Tolerances (per material type) apply.

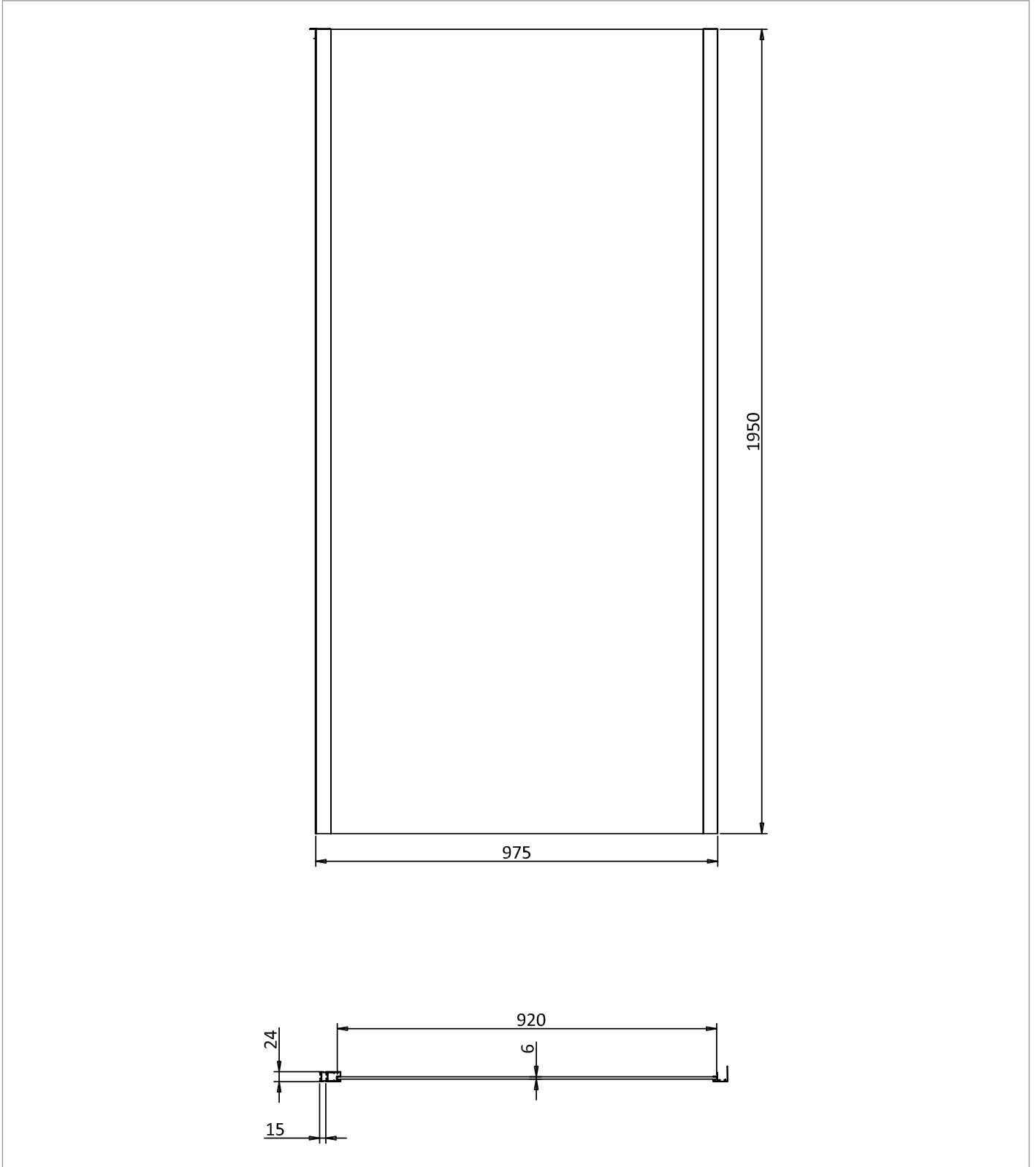

SPARES LIST

Only the parts labelled are available as spares.

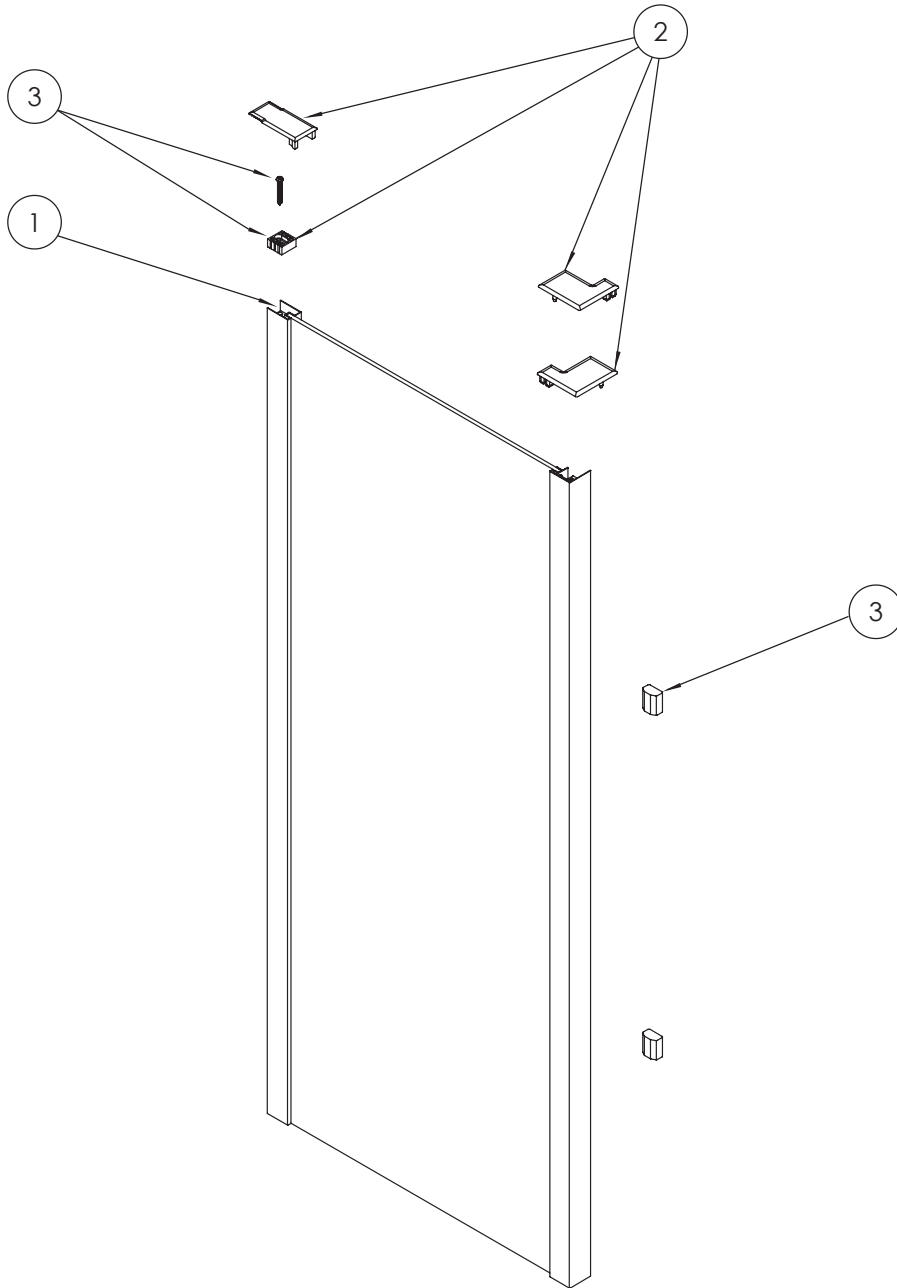

NUMBER	PART CODE	DESCRIPTION
1	ET0000031	Clear 6 Locking Levers
2	CA600017	Clear Side Panel Parts AB AC AD AE
3	CASIDEPACKF	Clear 6 Install Pack Side Panel Br Brass