



Product Brochure

Contents

Choice

The Keylite Promise - Customer Service Charter	2
Why Keylite?	4
Finish Options	10
Glazing Options	12

Innovation

keylite Connect®	14
Polar White PVC Roof Windows	18
Solar Powered Roof Windows	24
Integral Blinds	30
Roof Lantern	54

Pitched Roof Solutions

Centre Pivot Manual Roof Windows	20
Centre Pivot Electric Remote Roof Windows	22
Centre Pivot Solar Powered Roof Windows	26
Centre Pivot Electric Switch Roof Windows	28
Fire Escape/Top Hung Roof Windows	32
Conservation Roof Windows	34
QCP Enhanced Security Roof Windows	38
Dormer System	40
Fixed Shut Skylight	42
Combination Window Options	44
Vertical Bi-Lite Window System	46
Ridge Window	47
Pitched Roof Sunlite System	48
Smoke Ventilation Roof Windows	50

Flat Roof Solutions

Roof Lantern	54
Flat Roof System	56
Combination Flat Roof System	57
Flat Glass Rooflight	58
Low Rise Dome	59
Low Rise Access Hatch	60
Low Rise Smoke Ventilation	61
Flat Roof Sunlite System	48

Flashings

Roof Window Flashings	62
Single Flashings	64
Combination Flashings	65

Loft Ladders

Loft Ladder	66
-------------	----

Genuine Keylite Blinds

Genuine Keylite Blinds	68
Solar Powered Blinds	70
Thermal Blackout Blinds	72
Kids' Blinds	72
Dimout Blinds	74

Accessories

keylite Connect®	78
Electric Upgrade Kits	78
Window Opening Poles	78
Roof Window Support Trims	78
Maintenance Kits	78

Be Inspired

Case Studies	80
--------------	----



The **award winning Keylite** offer roof windows that combine energy efficiency with installation convenience and provide the optimum solution for more natural light and fresh air in your home.

The Keylite Promise - Customer Service Charter



Safety

We are passionate about providing an inclusive and safe working environment for all. We design safety into all our products. As a team, we strive towards a zero harm culture throughout the organisation.



Technical & Products

Our products meet and exceed all essential requirements in the form of directives, regulations and harmonised standards. Keylite Technical Support is available Monday to Fridays, 0800hrs - 1700hrs.



Customer Experience

We will collaboratively provide our customers with a friendly service where you feel valued and respected. Keylite provide our employees with the platform to be highly skilled, knowledgeable and ready to exceed our customers' expectations. We strive to answer 80% of all inbound calls within 10 seconds.



Operations & Delivery

We embrace an agile, continuous improvement culture; to ensure that we provide a first class service throughout the organisation. We commit to holding a core range in stock and achieve a minimum of 96% On Time, In Full delivery.



Sales & Marketing

80% of enquiries will be quoted within 24 hours, and 100% within 48 hours. For all orders placed before 1500hrs, you will receive an acknowledgement on the same day with a delivery date. We will provide you with a trusted Internal and External Sales professional, to support all of your needs.



Aftersales Support

On receipt of a query, our dedicated Customer Care Team shall make initial contact within two working days. 80% of customer visits will take place within eight working days by a certified Keylite Engineer. You can expect that a work completion certificate will be provided electronically within one working day of the visit taking place.



Roof Windows

We provide our customers with
a friendly, first class service
where they feel valued and
respected. Our staff are highly
skilled, knowledgeable and
always ready to exceed our
customers' expectations.

Why Keylite?



BUILDBASE
2015, 2016, 2017



BUILDERS MERCHANTS
NEWS AWARDS 2016



IRISH CONSTRUCTION
INDUSTRY AWARDS 2017



HOUSEBUILDER PRODUCT
AWARDS 2017



CONSTRUCTION NEWS
SPECIALISTS AWARDS 2018



BUILDBASE
2018



BUILDERS MERCHANTS JOURNAL
INDUSTRY AWARDS 2018



BARRATT DEVELOPMENT
PLC AWARDS 2019

Extra performance, no extra costs

Keylite provides all of its great features as standard. Other roof windows may require the use of accessories at an additional cost in order to achieve the same performance as Keylite.

Patented innovation

Keylite's unique integrated Expanding Thermal Collar assures thermal performance. Other unique features simplify the installation, operation and maintenance of our products.

Award-winning service

Keylite's technical experts are on hand to advise and assist you at the design and specification stage. When it comes to supply and delivery, our merchant stockists are at your service. Our aftersales service is professional and efficient with experienced engineers.

More choice

With a choice between timber or PVC materials, the Keylite range brings you more choice when selecting the right roof window for your project.

There are innovative upgrades available such as Solar Powered Roof Windows with 24 hour control from your smartphone via the **keylite**Connect® App and Hub.

10/20 year guarantee

Keylite Roof Windows and Flashings are covered by a 10 year guarantee, offering a 20 year guarantee on Polar White PVC (for further details visit keyliterateofwindows.com). All electric components, blinds and accessories are covered by a three year guarantee.

Approved

Keylite has gained certification from the relevant national bodies for both company's operating systems and products. Our third party certifications give you the confidence that Keylite products are the correct choice for your project.



The mark of
responsible forestry



Look for FSC® certified products.





Keylite Roof Windows combine innovative design with the latest in materials technology and precision manufacturing. **No other roof window** has Keylite's innovation for faster fitting, energy efficiency and easy maintenance, all as standard.

Faster

Faster, easier installation

Flick-Fit Brackets

Our unique Flick-Fit brackets are pre-fitted so you can lift the window straight from the box to the roof and install it faster, and simply select the setting for tile or slate. On-product fitting instructions and no loose brackets or screws help with the speed of installation.

Sash Hinge Finger Springs

This unique feature controls the movement of the sash hinge fingers, enabling the Installer to refit the sash into the frame in one smooth and easy motion.

Click Fit Hood

Simply click the hood under the clips and secure. The cover flashings require 50% fewer screws than before, making installation faster and easier than ever.

Warmer

Assured Thermal Performance

Expanding Thermal Collar

Keylite's unique integrated Expanding Thermal Collar insulates the frame within the roof expanding to combat thermal bridging and protect against condensation and mould.

Research has shown that for many buildings the thermal collar is necessary to prevent condensation and mould growth. Every Keylite Roof Window has a thermal collar built in, at no extra cost and exceeds the Building Regulation default values for thermal bridging as a result. Peace of mind that what is specified on your plan is the reality on site.



Lower

Streamlined fit as standard

Recessed installation

Every Keylite Roof Window is recessed as standard, sitting lower in the roof than before. This enhances the overall appearance of the roof and improves the thermal performance of the window.

No additional costs are incurred as the recessed fit is achieved with Keylite's standard flashing range.

Low profile hood

The Keylite hood has a low profile and features a sculptured design, enhancing its profile in the roof.

All Keylite Roof
Windows are
**recessed as
standard** and sit
lower in the roof,
improving thermal
performance.

Innovation as standard

Every **Keylite** Roof Window has all of our great features as standard. Other roof windows may require the use of additional cost accessories just to achieve the same performance as our award-winning Keylite Roof Windows.



Keylite Unique Innovation

Key Features

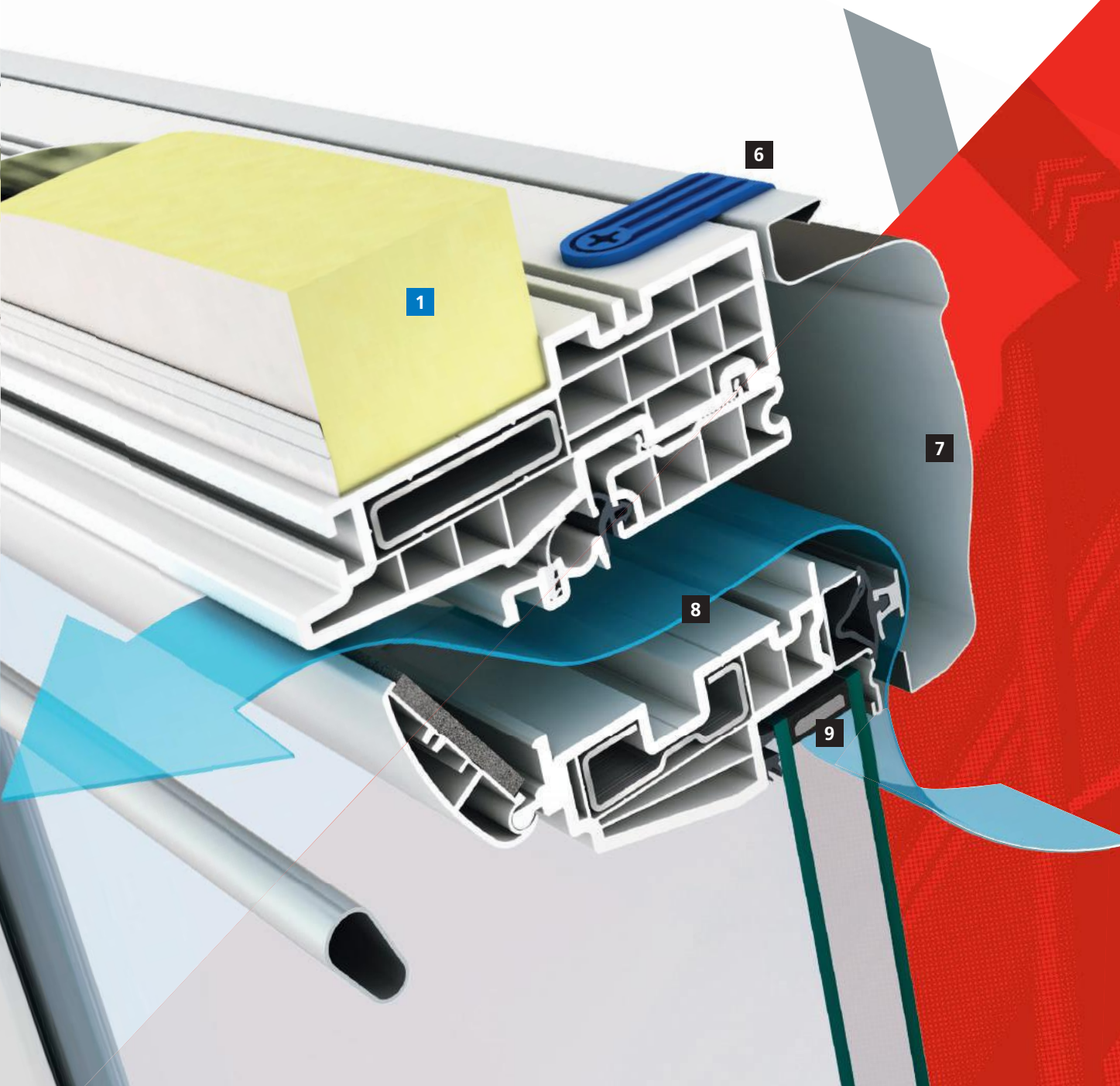

1 Expanding Thermal Collar

Simply pull away the release tape to activate our unique integrated Expanding Thermal Collar. It expands, filling the gap between the window frame and the roof, providing effective protection against cold bridging.

2 Ventilation Handle

Our slimline ventilation handle has a contemporary style, designed to provide comfortable opening of both the window and ventilation flap. The handle allows for trickle ventilation, even with the window fully closed and securely locked.

3 Maintenance Free Hinge

Keylite has eliminated the maintenance requirement of this vital moving component.

4 Sash Hinge Finger Springs

The Sash Hinge Finger Spring allows the sash to be installed back into the frame in one smooth, effortless motion.

5 Flick-Fit Brackets

Pre-fitted Flick-Fit brackets are easy to use and make Keylite installation faster from the box to the roof.

6 Click-Fit Hood & Cover Flashings

Simply position the hood under the pre-assembled hooks & click into place.

7 Low Profile Hood

The recessed fit is achieved with standard flashings which, together with the streamlined hood design, create a low profile.

8 All Weather Ventilation

Keylite Roof Windows provide trickle ventilation, even with the window fully closed and securely locked. The built-in insect filter ensures only clean, fresh air passes into the room.

9 Warm Edge Glazing

All glazing is upgraded as standard to warm edge, which adds protection against condensation.

Finish options - choose your perfect finish

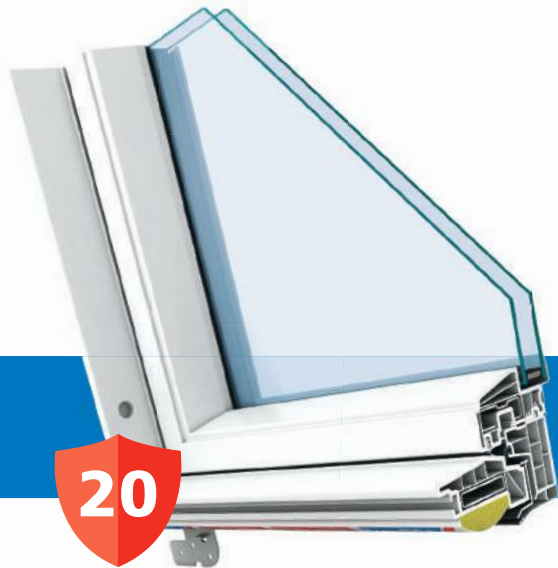

YEAR GUARANTEE

Keylite Polar White PVC

More daylight and a bright white surface complement the interior decoration of modern houses. Our white PVC profile is exceptionally moisture resistant and is therefore ideal as a maintenance-free solution for kitchens and bathrooms.

- **20 Year Guarantee*** - Centre Pivot only
- Premium grade PVC materials
- Moisture resistant
- Maintenance free
- Wipe clean
- Energy efficient
- Fast and easy installation



YEAR GUARANTEE

White Painted Pine

A contemporary style that looks good in every room. Our white painted roof window is treated with multiple coats of bright white paint, giving it moisture resistant properties. Choose white painted for a low maintenance, modern style which is ideal for use in kitchens and bathrooms.

- **10 Year Guarantee**
- Durable coating
- Ideal for contemporary interiors
- Ideal for kitchens and bathrooms
- Low maintenance
- Fast and easy installation



YEAR GUARANTEE

Clear Lacquered Pine

Our standard pine surface enhances the natural beauty of the wood, with a hard wearing, clear, satin lacquer applied in multiple coats. Choose Pine for a traditional look or to complement internal timber features.

- **10 Year Guarantee**
- Timber with clear satin lacquer applied in multiple coats
- Practical and hard-wearing
- Ideal for most interiors
- Fast and easy installation

* For further details visit keylitteroofwindows.com



We offer a choice of **finishes to complement your home** - maintenance free Polar White PVC or traditional pine frames, engineered from sustainable FSC-certified timber.

Glazing options



Thermal (T)



Hi Therm (HT)



Triple (KTG)



Integral Blind (I)

Glazing Type	Ug W/m².K	Rw, r dB	g %	Tv %	Tuv %
Thermal (T)	1.1	32	64	82	44
Hi Therm (HT)	1.1	36	64	81	0
Triple (KTG)	0.6	32	55	74	31
Integral Blind (I)	1.1	32	64	82	44

Ug Glazing U-Value
 dB Decibel rating
 g Total solar energy transmittance
 Tv Transmittance for standard illuminant
 Tuv UV transmittance

Energy efficient glazing

Keylite Roof Windows offer a choice of high performance glazing options to maximise energy efficiency. They can be supplied with a wide range of glazing variants including thermal properties, tinted, frosted and self-cleaning glass.

Thermal glazing (T)

Our standard Thermal unit features a 4mm toughened outer pane, a 4mm inner pane with a 20mm Argon gas filled cavity. It is also fitted with a warm edge glazing unit.

Hi-Therm glazing (HT)

Our Hi-Therm unit features 4mm toughened outer pane, an 18mm Argon gas filled cavity with a 6mm laminated inner pane. It is also fitted with a warm edge glazing unit. It's the ideal safety glazing for windows installed below 800mm from finish floor level or windows installed above head height. The design of this unit improves sound reduction and safety, while also offering a reduction in the harmful effects of UV light.

Triple glazing (KTG)

Our Triple glazed unit is our highest performing glazing element. It offers fantastic energy efficiency with a low U-Value. Constructed using three 4mm panes of glass with Krypton gas filled cavities, it also features a warm edge glazing unit with a toughened outer pane.

Integral glazing (I)

This unit features our unique integral blind. The blind is sealed within the glazing unit and provides protection against moisture and dust, making it ideal for kitchens and bathrooms. This double glazed unit comprises of two 4mm panes and a 20mm Argon gas filled cavity. It also features a toughened outer pane and a warm edge glazing unit. Our Integral unit is available with manual or electric operation. We recommend the electric operation for overhead or hard to reach areas.

Glazing finishes

Whether you want ease of cleaning, help in mitigating some of the effects of solar energy or simply increased privacy, Keylite has a selection of glazing finishes to choose from.



Bronze (BRT)



Frosted (FR)



Self-Cleaning (SC)



Keylite Roof Windows offer a choice of **high performance glazing** options to maximise energy efficiency.



Fingertip control of daylighting & ventilation

Transform the way you experience natural light and ventilation in your home with **keyliteConnect**® - the smart solution for automated control of Keylite Solar Roof Windows and blinds.

The **keyliteConnect**® Solar Powered Roof Windows are app enabled allowing you to set schedules and personal preferences to remotely control your roof windows and blinds using your smart device via your **keyliteConnect**® Hub.

Control

With **keyliteConnect**® you can monitor and control multiple Keylite Solar Roof Windows and Blinds at once, from anywhere in the world via an internet connection. With the tap of your phone or smart device, you can automatically open and close all Keylite solar operated roof window products and accessories in the property.

Ease of install

The straightforward set-up procedure within the app will guide you through the process, including pairing windows and assigning groups with personalised names to suit your own individual operational needs. You can easily integrate your app enabled Keylite Roof Windows and Blinds to the app, with our quick onboarding process.

Smart scheduling & personalisation

With the **keyliteConnect**® App you can set up pre-timed actions, such as airing your home, getting you up in the morning with a fresh air alarm clock and automatically lowering your blinds in the evening. It's even possible to allow your family to choose their own settings for their rooms.

Blind compatibility

Operate Keylite Electric Integral Blinds and Genuine Keylite Electric Blinds easily within the **keyliteConnect**® App.

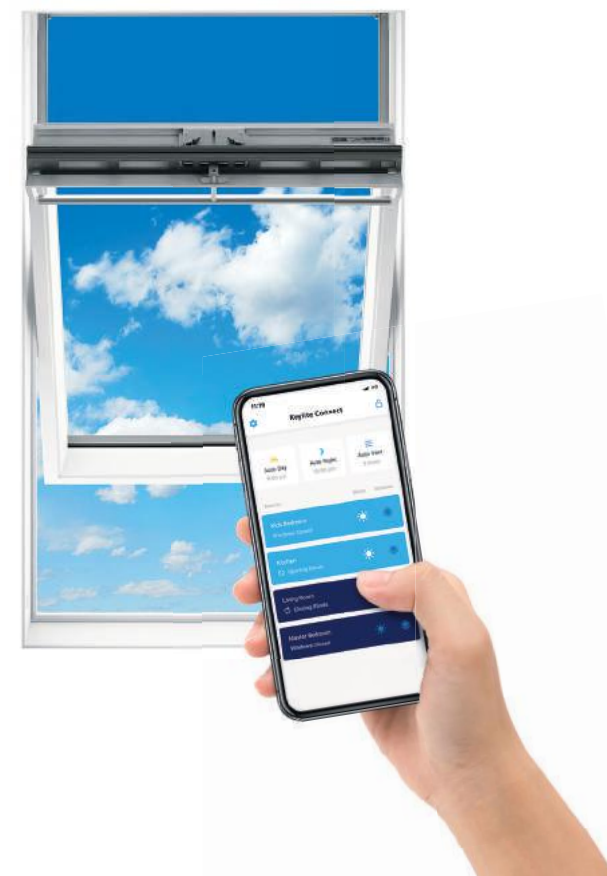



iPhone, iPod and iPad are registered trademarks of Apple Inc., registered in the U.S. and other countries and regions. App Store is a service mark of Apple Inc.

Google Play and the Google Play logo are trademarks of Google LLC.



Peace of mind

All **keyliteConnect**® enabled Roof Windows are fitted with a smart rain sensor that will automatically close the window in the event of rain, even when you are away from home.

You can open your roof windows to the trickle ventilation position to facilitate fresh air entering the property, while at the same time ensuring the building's safety is not compromised as windows remain in the fully locked position to prevent easy access.

Learn more

To find out more visit keyliterateofwindows.com/connect

Please note: **keyliteConnect**® App requires a **keyliteConnect**® Hub to operate. Only compatible with **keyliteConnect**® Solar Powered Roof Windows.

Working from your smart device, **keyliteConnect**® allows you to schedule and instantly control your solar roof windows and electric blinds remotely, when at home or away.

Pitched Roof Solutions



Pitched Roof Solutions

Creating the ultimate daylight experience for your home or extension doesn't need to be difficult. At Keylite we offer a range of roof solutions giving you plenty of opportunity to enhance the look of your home. Our pitched roof solutions offer a sleek, modern look and additional daylighting.

Adding a pitched roof window makes it effortless to flood natural daylight and fresh air into your home or extension, converting dull rooms into vibrant living spaces. Whatever your needs, there is a pitched roof solution designed to suit your requirements. Keylite Roof Windows feature a range of finish options, as well as a variety of high-performance glazing options to maximise energy efficiency.

Centre Pivot Roof Windows

The ideal choice for most applications, bringing natural light deeper into your home. Use multiple Centre Pivot Roof Windows to create impact in brighter, lighter living spaces and loft conversions.

The opening handle is conveniently placed at the top of the window and also controls ventilation, giving the option of fresh air flow even when the window is locked and secure.

Keylite Centre Pivot Roof Windows are available with manual, electric and solar operation.

Fire Escape Roof Windows

The Keylite Fire Escape Roof Window opens to 45°, complying with statutory regulations. This is ideal in low pitch roofs as the window opens outward, maximising the daylight that enters the room without the sash encroaching into your valuable internal space.

Conservation Roof Windows

The Keylite Conservation Roof Window is designed to complement both renovation and new build projects in a traditional style. The black Georgian glazing bar and low profile external flashing maintain the traditional character of the building, whilst still accommodating the flow of natural light to the interior below.

Keylite Conservation Roof Windows are available with either Centre Pivot or Top Hung opening method and with manual, electric and solar operation.

Vertical Bi-Lites

The Vertical Bi-Lite is a vertical window component, which combines with a Keylite Roof Window to produce an attractive glazing feature. This is a highly effective way to maximise the levels of light and ventilation in any room.



Ridge Systems

The Keylite Ridge System may be installed along the roof ridge to maximise light and space at the highest point of the pitched ceiling.

These are just some of the pitched roof solutions Keylite offer, the full range can be seen in this brochure.



Adding a pitched roof window makes it effortless to **flood natural daylight and fresh air into your home**, converting dull rooms into vibrant living spaces.



Polar[®]

White PVC Roof Windows

The ideal window for every room

Bright white

Polar White PVC Roof Windows combine the bright white finish of PVC with the latest in roof window design to complement the interior décor of the contemporary home.

The white interior finish blends perfectly with white ceilings to maximise the use of natural light within the room and works in harmony with the PVC windows found in modern homes.

Maintenance free

Polar's long life, bright white finish is guaranteed by the use of only premium grade PVC materials, ensuring that Polar remains maintenance free with only the occasional rub with a damp cloth required to retain its appearance. Therefore, unlike others, there is no need to ever repaint or varnish the interior surfaces. A special self-lubricating hinge has also been added for your convenience.

Moisture resistant

Keylite's Polar White PVC frame offers the ultimate protection against moisture making them ideal for every room, especially bathrooms and kitchens.

Energy efficient

The Polar White PVC range is unlike any other and features a unique integrated Expanding Thermal Collar which provides an instant barrier to heat loss and thermal bridging. It surrounds the frame with a thick insulating foam layer, filling the gap between the frame and the roof. In addition, every Polar White PVC Roof Window features warm edge glazing technology and gas filled glazing units to enhance overall energy efficiency.

Easily fitted

Keylite Roof Windows are designed to reduce the time and effort required for installation. Our patented Flick-Fit brackets are pre-fitted to the window, saving the installer valuable time and energy. This built-in innovation, at no extra cost, enables the window to be taken from the box to the roof in just two minutes, while a host of other features combine to make Keylite extremely fitter friendly.



Extended Guarantee*
**20 Years on Polar White PVC
Centre Pivot Roof Windows**

* For further details visit keyliterateofwindows.com

The **Keylite Polar White PVC** range is like no other. Keylite's unique innovations for faster fitting, energy efficiency and low maintenance, all included as standard at no extra cost. Plus up to a 20 year customer guarantee.

Centre Pivot Roof Windows CP

The ideal choice for most applications, bringing natural light deeper into your home. Use multiple Centre Pivot windows to create impact in brighter, lighter living spaces and loft conversions.

The opening handle is conveniently placed at the top of the window and also controls ventilation, giving the option of fresh air flow even when the window is locked and secure.



Manual operation

Centre Pivot Roof Windows CP

Code	Description	Size WxH (mm)										
		01	02	01C	03	04	05	06	07F	07	08	09
Polar White PVC												
PCP T	Polar Centre Pivot, Thermal Glazing	•	•	•	•	•	•	•	•	•	•	•
PCP HT	Polar Centre Pivot, Hi Therm Glazing	•	•	•	•	•	•	•	•	•	•	•
PCP TFR	Polar Centre Pivot, Frosted Glazing	•	•	•	•	•	•	•	•	•	•	•
PCP KTG	Polar Centre Pivot, Triple Glazing	•	•	•	•	•	•	•	•	•	•	•
PCP I°	Polar Centre Pivot, Manual Integral Blind	•	•	•	•	•	•	•	•	•	•	•
White Painted Pine												
WCP T	White Finish Centre Pivot, Thermal Glazing	•	•	•	•	•	•	•	•	•	•	•
WCP HT	White Finish Centre Pivot, Hi Therm Glazing	•	•	•	•	•	•	•	•	•	•	•
WCP KTG	White Finish Centre Pivot, Triple Glazing	•	•	•	•	•	•	•	•	•	•	•
WCP I°	White Finish Centre Pivot, Manual Integral Blind	•	•	•	•	•	•	•	•	•	•	•
Clear Lacquered Pine												
TCP T	Pine Centre Pivot, Thermal Glazing	•	•	•	•	•	•	•	•	•	•	•
TCP HT	Pine Centre Pivot, Hi Therm Glazing	•	•	•	•	•	•	•	•	•	•	•
TCP KTG	Pine Centre Pivot, Triple Glazing	•	•	•	•	•	•	•	•	•	•	•
TCP I°	Pine Centre Pivot, Manual Integral Blind	•	•	•	•	•	•	•	•	•	•	•



° Manual integral blind is not for out of reach use.

Frosted glazing (TFR) is also available on White Painted & Clear Lacquered Pine roof windows. Contact the Keylite Sales Team for more information.



10 year guarantee on Timber Roof Windows.

20 year guarantee on Polar White PVC Roof Windows.

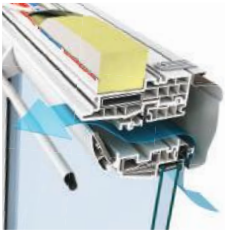

Fresh Air

One click on the top handle provides ventilation, pull further to open for fresh air.



Attractive Styling

Choose bright white for contemporary interiors or lacquered pine for a more traditional look.



Easy Cleaning

Window rotates 180° to clean the glass from inside the room.



The **Centre Pivot** Roof Window is Keylite's most popular and versatile choice, suitable for most applications.

Centre Pivot Roof Windows PEK

The Centre Pivot Electric Roof Windows are the ideal choice for out of reach areas. The electric PEK windows are supplied with a handheld remote control and will close automatically in the event of rain.

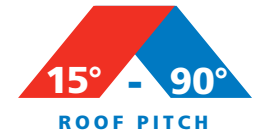

Electric operation

Premium Electric Kit with Remote Control and Rain Sensor **PEK**

Code	Description	01	02	01C	03	04	05	06	07F	07	08	09	10
Size WxH (mm)		550x780	550x980	550x1180	660x1180	780x980	780x1180	780x1400	940x1400	940x1600	1140x1180	1340x980	1340x1400

Polar White PVC

PCP T PEK	Polar Centre Pivot, Thermal Glazing	•	•	•	•	•	•	•	•		•	•	•
PCP HT PEK	Polar Centre Pivot, Hi-Therm Glazing	•	•	•	•	•	•	•	•		•	•	
PCP KTG PEK	Polar Centre Pivot, Triple Glazing	•	•	•	•	•	•	•	•		•	•	
PCP EI PEK	Polar Centre Pivot, Electric Integral Blind	•	•	•	•	•	•	•	•		•	•	

White Painted Pine

WCP T PEK	White Finish Centre Pivot, Thermal Glazing	•	•	•	•	•	•	•	•	•	•	•	•
WCP HT PEK	White Finish Centre Pivot, Hi-Therm Glazing	•	•	•	•	•	•	•	•	•	•	•	•
WCP KTG PEK	White Finish Centre Pivot, Triple Glazing	•	•	•	•	•	•	•	•	•	•	•	•
WCP EI PEK	White Finish Centre Pivot, Electric Integral Blind	•	•	•	•	•	•	•	•	•	•	•	

KeyliteConnect® Clear Lacquered Pine

TCP T PEK	Pine Centre Pivot, Thermal Glazing	•	•	•	•	•	•	•	•	•	•	•	•
TCP HT PEK	Pine Centre Pivot, Hi-Therm Glazing	•	•	•	•	•	•	•	•	•	•	•	•
TCP KTG PEK	Pine Centre Pivot, Triple Glazing	•	•	•	•	•	•	•	•	•	•	•	•
TCP EI PEK	Pine Centre Pivot, Electric Integral Blind	•	•	•	•	•	•	•	•	•	•	•	



3 year guarantee on electrical components.

10 year guarantee on Timber Roof Windows.

20 year guarantee on Polar White PVC Roof Windows.

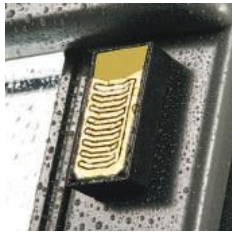

Rain Sensor for Auto Closing

Smart rain sensor will automatically close the window in the event of rain, even when you are away from home.



Handheld Remote Control

Control your roof windows and blinds using the remote control at the touch of a button.



Keylite Electric Roof Windows are **ideal for hard to reach areas.**



Solar[®]
Powered Roof Windows

Let the sun do the work

Our **keyliteConnect**[®] Solar Powered Roof Windows are the ultimate solution for sustainable homes and available as an option for Centre Pivot Roof Windows.

keyliteConnect[®] Solar Roof Windows harvest solar energy which is retained in the roof window's battery system. With no need for mains electricity, the Solar Powered Roof Window harnesses this energy allowing you to operate your windows day and night.

The **keyliteConnect**[®] Solar range can also be supplied with electric blinds for complete control of natural light and ventilation solutions in your home. The Polar White PVC finish option provides a moisture resistant, maintenance free solution, making them ideal for damp environments like bathrooms and kitchens.



keyliteConnect[®] compatible

See page 14 for details.





Rain Sensor for Auto Closing

Smart rain sensor will automatically close the window in the event of rain, even when you are away from home.



Handheld Remote Control

Control your roof windows and blinds using the remote control at the touch of a button.



keyliteConnect® Compatible

The app allows you to set schedules and personal preferences to remotely control your roof windows and blinds using your smart device via your **keyliteConnect®** Hub. See page 14 for details.

keyliteConnect® Solar
Roof Windows are **app
enabled and perfect for
out of reach areas.** They
also work without the need
of a mains electricity supply.

Centre Pivot Roof Windows KCS



keyliteConnect® Solar Roof Windows are the ultimate solution for sustainable homes. The **keyliteConnect**® range of solar powered roof windows are app enabled, allowing you to set schedules and personal preferences to remotely control your roof windows and blinds using your smart device via the **keyliteConnect**® Hub.

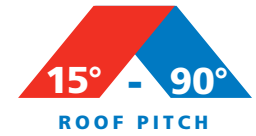

Solar operation

KeyliteConnect® Solar with Remote Control and Rain Sensor KCS

Code	Description	01	02	01C	03	04	05	06	07F	07	08	09	10
Size WxH (mm)		550x780	550x980	550x1180	660x1180	780x980	780x1180	780x1400	940x1400	940x1600	1140x1180	1340x980	1340x1400

KeyliteConnect® Polar White PVC

PCP T KCS	Polar Centre Pivot, Thermal Glazing	•	•	•	•	•	•	•	•		•	•	•
PCP HT KCS	Polar Centre Pivot, Hi-Therm Glazing	•	•	•	•	•	•	•	•		•	•	
PCP KTG KCS	Polar Centre Pivot, Triple Glazing	•	•	•	•	•	•	•	•		•	•	
PCP EI KCS	Polar Centre Pivot, Electric Integral Blind	•	•	•	•	•	•	•	•		•	•	

KeyliteConnect® White Painted Pine

WCP T KCS	White Finish Centre Pivot, Thermal Glazing	•	•	•	•	•	•	•	•	•	•	•	•
WCP HT KCS	White Finish Centre Pivot, Hi-Therm Glazing	•	•	•	•	•	•	•	•	•	•	•	•
WCP KTG KCS	White Finish Centre Pivot, Triple Glazing	•	•	•	•	•	•	•	•	•	•	•	•
WCP EI KCS	White Finish Centre Pivot, Electric Integral Blind	•	•	•	•	•	•	•	•	•	•	•	

KeyliteConnect® Clear Lacquered Pine

TCP T KCS	Pine Centre Pivot, Thermal Glazing	•	•	•	•	•	•	•	•	•	•	•	•
TCP HT KCS	Pine Centre Pivot, Hi-Therm Glazing	•	•	•	•	•	•	•	•	•	•	•	•
TCP KTG KCS	Pine Centre Pivot, Triple Glazing	•	•	•	•	•	•	•	•	•	•	•	•
TCP EI KCS	Pine Centre Pivot, Electric Integral Blind	•	•	•	•	•	•	•	•	•	•	•	



3 year guarantee on electrical components.

10 year guarantee on Timber Roof Windows.

20 year guarantee on Polar White PVC Roof Windows.



Rain Sensor for Auto Closing

Smart rain sensor will automatically close the window in the event of rain, even when you are away from home.



Handheld Remote Control

Control your roof windows and blinds using the remote control at the touch of a button.



keyliteConnect® Compatible

The app allows you to set schedules and personal preferences to remotely control your roof windows and blinds using your smart device via your **keyliteConnect®** Hub. See page 14 for details.



keyliteConnect® Solar stores up power for operation during the day and night. Electrical operation of blinds can also be added.

Centre Pivot Roof Windows SEK

Keylite Switch Roof Windows are perfect for rooms with a single, out of reach window. The roof window can be opened easily using the electrically operated wall mounted switch.

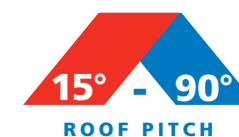

Electric operation

Keylite Switch Electric with wall mounted switch **SEK**

Code	Description	01	02	01C	03	04	05	06	07F	07	08	09	10
Size WxH (mm)		550x780	550x980	550x1180	660x1180	780x980	780x1180	780x1400	940x1400	940x1600	1140x1180	1340x980	1340x1400

Polar White PVC

PCP T SEK	Polar Centre Pivot, Thermal Glazing	•	•	•	•	•	•	•	•		•	•	•
PCP HT SEK	Polar Centre Pivot, Hi-Therm Glazing	•	•	•	•	•	•	•	•		•	•	
PCP KTG SEK	Polar Centre Pivot, Triple Glazing	•	•	•	•	•	•	•	•		•	•	
PCP EIS SEK*	Polar Centre Pivot, Electric Integral Blind	•	•	•	•	•	•	•	•		•	•	

White Painted Pine

WCP T SEK	White Finish Centre Pivot, Thermal Glazing	•	•	•	•	•	•	•	•	•	•	•	•
WCP HT SEK	White Finish Centre Pivot, Hi-Therm Glazing	•	•	•	•	•	•	•	•	•	•	•	•
WCP KTG SEK	White Finish Centre Pivot, Triple Glazing	•	•	•	•	•	•	•	•	•	•	•	•
WCP EIS SEK*	White Finish Centre Pivot, Electric Integral Blind	•	•	•	•	•	•	•	•	•	•	•	

Clear Lacquered Pine

TCP T SEK	Pine Centre Pivot, Thermal Glazing	•	•	•	•	•	•	•	•	•	•	•	•
TCP HT SEK	Pine Centre Pivot, Hi-Therm Glazing	•	•	•	•	•	•	•	•	•	•	•	•
TCP KTG SEK	Pine Centre Pivot, Triple Glazing	•	•	•	•	•	•	•	•	•	•	•	•
TCP EIS SEK*	Pine Centre Pivot, Electric Integral Blind	•	•	•	•	•	•	•	•	•	•	•	

* Comes with two wall mounted switches.



3 year guarantee on electrical components.

10 year guarantee on Timber Roof Windows.

20 year guarantee on Polar White PVC Roof Windows.

Switch Features



Wall Mounted Switch

The wall mounted electrical unit requires hard wiring to the mains and will operate your windows and blinds at the touch of a button.

Keylite Switch Roof Windows are perfect **for rooms with a single, out of reach window.** Electrical operation of blinds can also be added as an option.

Integral Blinds - unique to Keylite

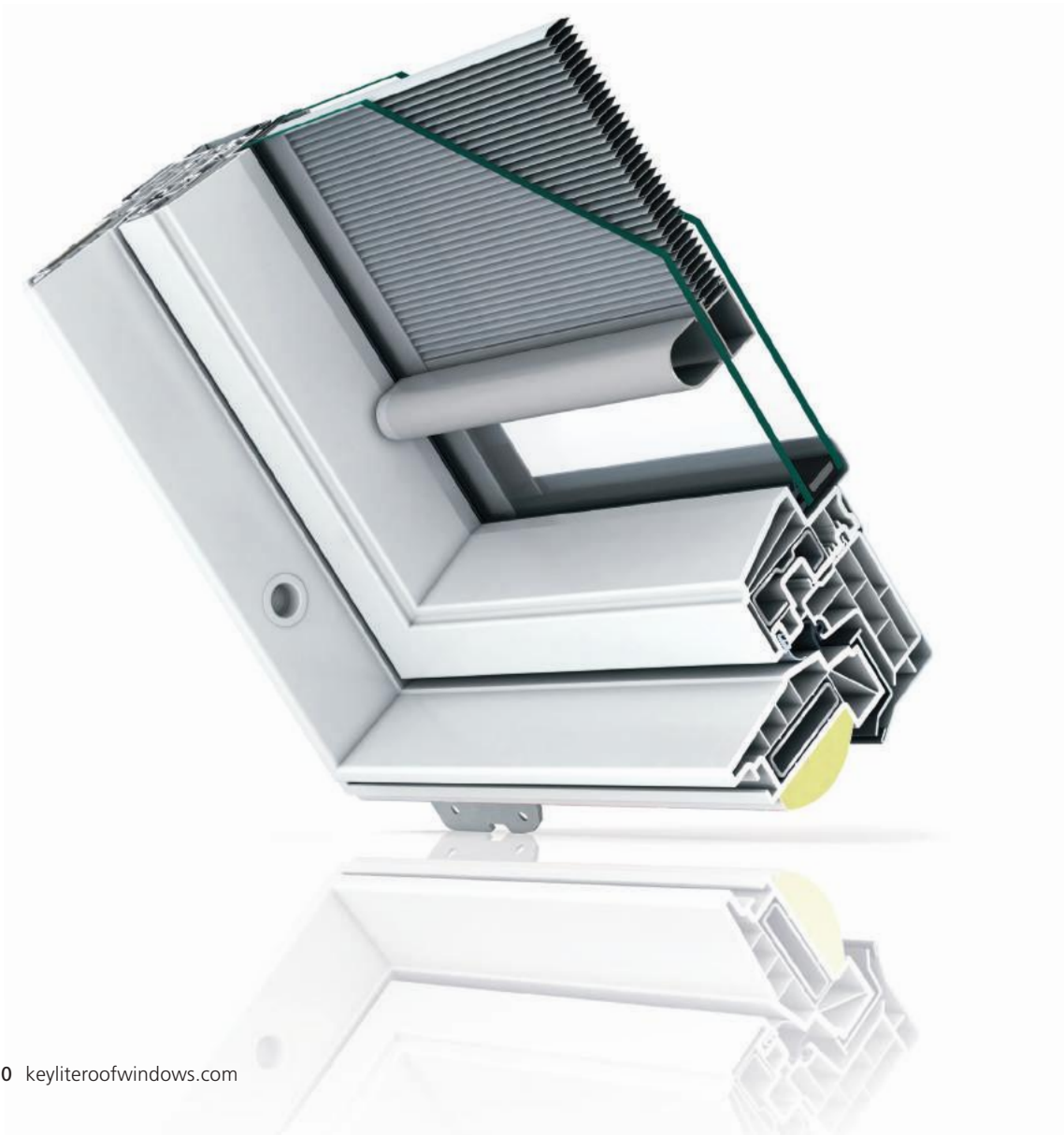

Electric Integral Blinds are the optimum control for overhead roof windows. The blind is sealed within the glazing unit and is ideal for use in damp or dusty environments.

Factory fitted blind

As the blind is sealed within the glazing unit it requires no cleaning as it is housed in an entirely dust free environment. This makes it the ideal choice for hospitals and other sterile/hygienic environments.

Enhanced sun shading

The blind consists of dimout fabric to help reduce the glare of the sun ensuring human comfort levels can be maintained within the room.

Multiple application

The Keylite Electric Integral Blind is compatible with the **keyliteConnect**® Hub and App and can therefore be operated via your mobile phone or smart device. It can also be operated by handheld remote control or wall mounted switch and is available with manual operation. All versions are available throughout the Keylite Roof Window range in standard sizes only. The manual blind is available in blackout fabric while our electric blind is available in dimout fabric only.



The Keylite Integral Blind Roof Window range features a factory fitted blind that is permanently **sealed within the energy efficient** double glazing unit.

Fire Escape/Top Hung Roof Windows FE/TH

The Keylite Fire Escape/Top Hung Roof Window opens to 45°, complying with statutory regulations. This is ideal in low pitch roofs as the window opens outward, maximising the daylight that enters the room without the sash encroaching into your valuable internal space.



Manual operation

Fire Escape/Top Hung Roof Windows FE/TH

Code	Description	01	02	01C	03	04	05	06	07F	07	08	09	10
	Size WxH (mm)	550x780	550x980	550x1180	660x1180	780x980	780x1180	780x1400	940x1400	940x1600	1140x1180	1340x980	1340x1400

Polar White PVC

PFE T	Polar Fire Escape/Top Hung, Thermal Glazing		•	•	•	•	•	•	•		•	•	
PFE HT	Polar Fire Escape/Top Hung, Hi-Therm Glazing		•	•	•	•	•	•	•		•	•	
PFE KTG	Polar Fire Escape/Top Hung, Triple Glazing		•	•	•	•	•	•	•		•		
PFE I	Polar Fire Escape/Top Hung, Integral Blind		•	•	•	•	•	•	•		•		

White Painted Pine

WFE T	White Finish Fire Escape/Top Hung, Thermal Glazing		•	•	•	•	•	•	•	•	•	•	•
WFE HT	White Finish Fire Escape/Top Hung, Hi-Therm Glazing		•	•	•	•	•	•	•	•	•	•	
WFE KTG	White Finish Fire Escape/Top Hung, Triple Glazing		•	•	•	•	•	•	•	•	•		
WFE I	White Finish Fire Escape/Top Hung, Integral Blind		•	•	•	•	•	•	•	•	•		

Clear Lacquered Pine

TFE T	Pine Fire Escape/Top Hung, Thermal Glazing		•	•	•	•	•	•	•	•	•	•	•
TFE HT	Pine Fire Escape/Top Hung, Hi-Therm Glazing		•	•	•	•	•	•	•	•	•	•	
TFE KTG	Pine Fire Escape/Top Hung, Triple Glazing		•	•	•	•	•	•	•	•	•		
TFE I	Pine Fire Escape/Top Hung, Integral Blind		•	•	•	•	•	•	•	•	•		

- Due to opening size an 02 roof window must not be used as a means of escape - Code for 02 roof window is 'TH' (Top Hung).
Frosted glazing (TFR) is available on Polar White PVC, White Painted & Clear Lacquered Pine roof windows. Contact the Keylite Sales Team for more information.



10 year guarantee on Timber Roof Windows.

20 year guarantee on Polar White PVC Roof Windows.

Means of Escape

As a means of escape, the window opens to an unobstructed area for safe exit in the event of an emergency. The opening handle located at the bottom of the window is easily accessible.

Easy to Use

The multi-stop opening feature allows the user to simply push the window to any position between 0° and 45° and remain open for maximum flexibility.

Effective Ventilation

Effective ventilation is provided by the vent handle at the top of the window which regulates the air flow, even when the window is closed.

Thermal Performance

Only Keylite windows have an integrated Expanding Thermal Collar, Warm Edge Glazing and a Streamlined Fit as standard, providing assured thermal performance.

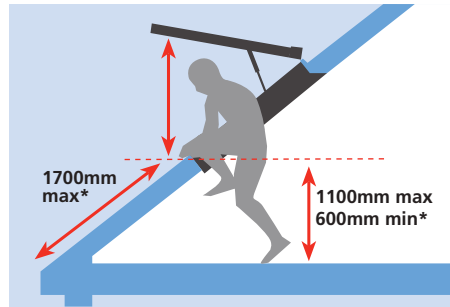
**Fire Escape**

The window should have an unobstructed openable area that is at least 0.33m² and at least 450mm high and 450mm wide.

* Check with your local Building Control Department with regards to the position of the window prior to installation.



The Keylite Fire Escape Roof
Window opens to 45°,
 complying with statutory
 safety regulations.

Conservation Roof Windows CW



The Keylite Conservation Roof Window is designed to complement both renovation and new build projects in a traditional style. The black Georgian glazing bar and low profile external flashing maintain the traditional character of the building, whilst still accommodating the flow of natural light to the interior below.

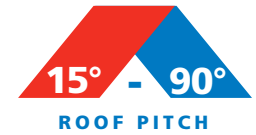

Manual operation

Centre Pivot Conservation Roof **CW** (Product also available with **keyliteConnect**[®])

Code	Description	01	02	01C	03	04	05	06	07F	07	08*	09*	10*
Size WxH (mm)		550x780	550x980	550x1180	660x1180	780x980	780x1180	780x1400	940x1400	940x1600	1140x1180	1340x980	1340x1400

Polar White PVC

CW PCP T	Conservation, Polar Centre Pivot, Thermal Glazing	•	•	•	•	•	•	•	•		•	•	•
CW PCP HT	Conservation, Polar Centre Pivot, Hi-Therm Glazing	•	•	•	•	•	•	•	•		•	•	
CW PCP I	Conservation, Polar Centre Pivot, Integral Blind	•	•	•	•	•	•	•	•		•	•	

White Painted Pine

CW WCP T	Conservation, White Finish Centre Pivot, Thermal Glazing	•	•	•	•	•	•	•	•	•	•	•	•
CW WCP HT	Conservation, White Finish Centre Pivot, Hi-Therm Glazing	•	•	•	•	•	•	•	•	•	•	•	•
CW WCP I	Conservation, White Finish Centre Pivot, Integral Blind	•	•	•	•	•	•	•	•	•	•	•	

Clear Lacquered Pine

CW TCP T	Conservation, Pine Centre Pivot, Thermal Glazing	•	•	•	•	•	•	•	•	•	•	•	•
CW TCP HT	Conservation, Pine Centre Pivot, Hi-Therm Glazing	•	•	•	•	•	•	•	•	•	•	•	•
CW TCP I	Conservation, Pine Centre Pivot, Integral Blind	•	•	•	•	•	•	•	•	•	•	•	

* Please note sizes 08, 09 & 10 will include two Georgian bars. Sizes also available without Georgian bar - use variant NGB at the end of product code.

Note: Polar White Polar PVC window sizes 06 and 07F include 1 bottom handle. Sizes 08, 09 and 10 will include 2 bottom handles.



10 year guarantee on Timber Roof Windows.

20 year guarantee on Polar White PVC Roof Windows.

CW Features

Classic Design

While traditional in its external appearance, the standard Conservation Roof Window benefits from all of the advanced Keylite features including thermal efficiency, low maintenance and ventilation control.

Centre Pivot

Centre Pivot Conservation Roof Windows available in PVC, White Finish and Pine.

Thermal Performance

Only Keylite windows have an integrated Expanding Thermal Collar, Warm Edge Glazing and a Streamlined Fit as standard, providing assured thermal performance.

The Keylite Conservation Roof Window is **designed to complement** both renovation and new build projects in a traditional style.

Conservation Roof Windows CW

The Keylite Conservation Roof Window is designed to complement both renovation and new build projects in a traditional style. The black Georgian glazing bar and low profile external flashing maintain the traditional character of the building, whilst still accommodating the flow of natural light to the interior below.

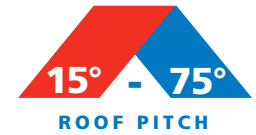

Manual operation

Fire Escape/Top Hung Conservation Roof CW

Code	Description	02*	01C	03	04	05	06	07F	07	08*	09*	10*
Size WxH (mm)		550x980	550x1180	660x1180	780x980	780x1180	780x1400	940x1400	940x1600	1140x1180	1340x980	1340x1400



Polar White PVC

CW PFE T	Conservation, Fire Escape/Top Hung, Thermal Glazing	•	•	•	•	•	•	•	•	•	•	•
CW PFE HT	Conservation, Fire Escape/Top Hung, Hi-Therm Glazing	•	•	•	•	•	•	•	•	•	•	•
CW PFE I	Conservation, Fire Escape/Top Hung, Integral Blind	•	•	•	•	•	•	•	•	•	•	•

White Painted Pine

CW WFE T	Conservation, White Finish Fire Escape/Top Hung, Thermal Glazing	•	•	•	•	•	•	•	•	•	•	•
CW WFE HT	Conservation, White Finish Fire Escape/Top Hung, Hi-Therm Glazing	•	•	•	•	•	•	•	•	•	•	•
CW WFE I	Conservation, White Finish Fire Escape/Top Hung, Integral Blind	•	•	•	•	•	•	•	•	•	•	•

Clear Lacquered Pine

CW TFE T	Conservation, Pine Fire Escape/Top Hung, Thermal Glazing	•	•	•	•	•	•	•	•	•	•	•
CW TFE HT	Conservation, Pine Fire Escape/Top Hung, Hi-Therm Glazing	•	•	•	•	•	•	•	•	•	•	•
CW TFE I	Conservation, Pine Fire Escape/Top Hung, Integral Blind	•	•	•	•	•	•	•	•	•	•	•

- Due to opening size an 02 roof window must not be used as a means of escape - Code for 02 roof window is 'TH'
- * Please note sizes 08, 09 & 10 will include two Georgian bars. Sizes also available without Georgian bar - use variant NGB at the end of product code.



10 year guarantee on Timber Roof Windows.

20 year guarantee on Polar White PVC Roof Windows.

Classic Design

While traditional in its external appearance, the standard Conservation Roof Window benefits from all of the advanced Keylite features including thermal efficiency, low maintenance and ventilation control.

FireEscape/Top Hung

Fire Escape/Top Hung Conservation Roof Windows available in PVC, White Finish and Pine.

Thermal Performance

Only Keylite windows have an Expanding Thermal Collar, Warm Edge Glazing and a Streamlined Fit as standard, providing assured thermal performance.

The black **Georgian glazing bar and low profile** external flashing maintain the traditional character of the building.

Keylite QCP Roof Windows QCP

The Keylite QCP Roof Window offers enhanced levels of safety and security on the Keylite Centre Pivot range. Bottom handles have been incorporated into the design of this window to provide an additional locking mechanism. Furthermore, all glazing borders are fitted with non-reverse screws to prevent ease of access through the glazing pane.

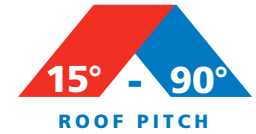

Enhanced security

Keylite QCP Roof Windows Part Q Compliant QCP

Code	Description	01	02	01C	03	04	05	06	07F	07	08	09	10
Size WxH (mm)		550x780	550x980	550x1180	660x1180	780x980	780x1180	780x1400	940x1400	940x1600	1140x1180	1340x980	1340x1400



White Painted Pine

QWCP HT	White Finish, Centre Pivot, Hi-Therm Glazing	•	•	•	•	•	•	•	•	•	•	•	•
----------------	--	---	---	---	---	---	---	---	---	---	---	---	---

Clear Lacquered Pine

QTCP HT	Pine, Centre Pivot, Hi-Therm Glazing	•	•	•	•	•	•	•	•	•	•	•	•
----------------	--------------------------------------	---	---	---	---	---	---	---	---	---	---	---	---

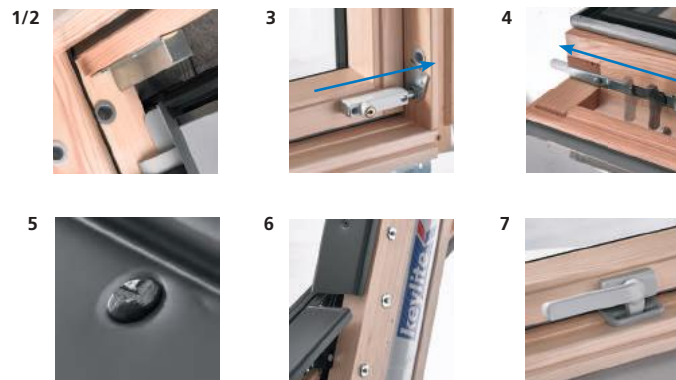
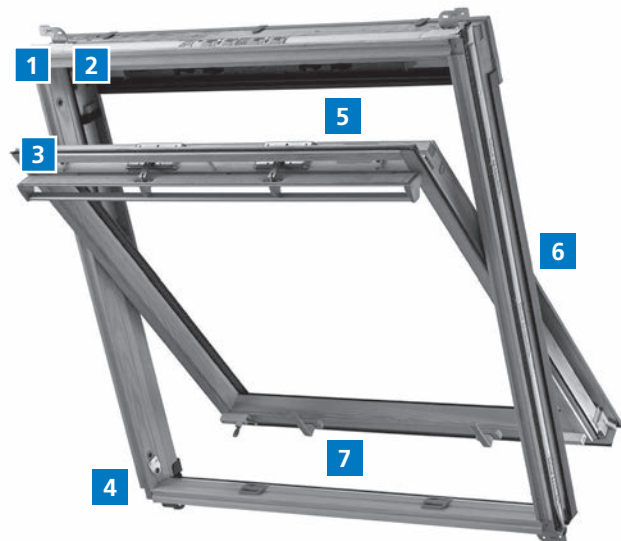

The Keylite QCP window is tested to PAS 24:2012 and has attained a pass for all aspects of this testing programme.



10 year guarantee on Timber Roof Windows.

QCP Features

- 1 The standard plastic locking bolt thimble is replaced with a metal version on either side.
- 2 The locking bolts are fitted with a protective metal cover/shroud.
- 3 The standard plastic locking bolt found at the top of the sash is replaced with a solid metal version. For those windows which only have one locking bolt fitted, these will be fitted with two metal versions; one at each top corner of the sash.
- 4 Additional ERA 806 press bolts are fitted to the bottom of the sash at each corner. These are supplied with a key to unlock. The keys will be tied up like the blinds tag to stop them from being misplaced or snapped in the lock whilst installing the window.
- 5 All glazing borders are fitted with non-reverse screws, this means any glazing related issue will have to be resolved using a replacement sash, not reglazed on site.
- 6 Frame hinge screws are replaced with frame hinge bolts which are secured using spigot nuts from the outside of the frame.
- 7 All sizes will be complete with two bottom handles and keeps, apart from the 550mm wide frames, which will only have one handle and one keep in the centre.

The Keylite QCP
Roof Window offers
**enhanced levels of
safety and security**
on the Keylite Centre
Pivot range.

Dormer System DRX



The Keylite Dormer System opens up the opportunity for a unique fresh air experience with the convenience of the top handle on our Centre Pivot Roof Windows, allowing easy opening to create a well ventilated and bright space.



Manual operation Centre Pivot Roof Windows CP

Size Code	DRX4 04	DRX4 05	DRX4 07B	DRX4 07C	DRX4 08B	DRX4 08	DRX6 04	DRX6 05
Individual Roof Window Size (WxH) mm	780 x 980	780 x 1180	940 x 980	940 x 1180	1140 x 980	1140 x 1180	780 x 980	780 x 1180
Structural Opening Size (WxH) mm	1550 x 2095	1870 x 2095	1550 x 2470	1870 x 2470	2270 x 2095	2270 x 2470	2350 x 2095	2350 x 2470



Follow these steps when choosing a Keylite Dormer System

STEP 1

Decide if the system you require is a configuration of 4 or 6 roof windows.
Special consideration should be given to structural opening sizes.
Note: Check with your local Building Control Department prior to installation.



STEP 2

Select a size for your Centre Pivot Roof Windows based on your roof pitch:

- Sizes 05, 07C & 08 require a roof pitch between 35 - 70°
- Sizes 04, 07B & 08B require a roof pitch between 40 - 70°



STEP 3

Choose your finish and glazing:

- Polar White PVC, Pine or White Finish
- Glazing options (Hi-Therm recommended)
- Integral Blind



STEP 4

Choose your roof finish:

- Slate or Tile

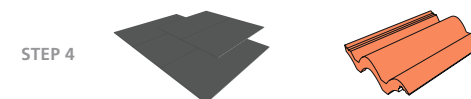

For optimum use we recommend **keyliteConnect**[®] Solar Centre Pivot Roof Windows.
See page 14 for more information.

Note: Roof windows are to be costed separately.



10 year guarantee on Dormer System and Timber Roof Windows.

20 year guarantee on Polar White PVC Roof Windows.

Benefits

The new Keylite Dormer System is a dramatic alternative to a traditional roof dormer.

Available in a configuration of 4 or 6 roof windows, the Keylite Dormer can be made even more practical with the selection of Electric or Solar powered options for maximum fingertip control.

Bringing many of the same advantages in terms of space and head room whilst adding dramatic visual impact. The Dormer System transmits more than three times the daylight, as the overhead glazing floods natural light into your living space. Internally, the colour matched trimmers create an attractive window feature.

Features

The Keylite Dormer comes with a fully insulated frame work and all associated aluminium flashing components required to complete the installation. Also included are colour matched internal decorative trims.

Note: The Keylite Dormer Kit refers only to the frame work, flashings and decorative trims. For a complete system, the roof windows must be specified separately.

For further information, contact the Keylite Sales Team (see the back of the brochure for contact details).



The Keylite Dormer System
transmits **more than three
times the natural daylight**
provided by a traditional
roof dormer.

Fixed Shut Skylight SKF

See the sky and experience natural daylight in your home with a non opening skylight. A Fixed Shut Skylight is ideal to flood living spaces with natural light in circumstances where opening and closing is not required. The inclusion of a Fixed Shut Skylight provides maximum daylight and provides a streamlined look internally.



Non opening Fixed Shut Skylight SKF

Code	Description	01	02	01C	03	04	05	06	07F	07	08	09	10
Size WxH (mm)		550x780	550x980	550x1180	660x1180	780x980	780x1180	780x1400	940x1400	940x1600	1140x1180	1340x980	1340x1400

Fixed Shut Skylight with Tile Flashing - White Painted Pine

SKF T TRF	Fixed Shut Skylight, Thermal Glazing, Tile Flashing	•	•	•	•	•	•	•	•	•	•	•	•
SKF HT TRF	Fixed Shut Skylight, Hi-Therm Glazing, Tile Flashing	•	•	•	•	•	•	•	•	•	•	•	•

Fixed Shut Skylight with Slate Flashing - White Painted Pine

SKF T SRF	Fixed Shut Skylight, Thermal Glazing, Slate Flashing	•	•	•	•	•	•	•	•	•	•	•	•
SKF HT SRF	Fixed Shut Skylight, Hi-Therm Glazing, Slate Flashing	•	•	•	•	•	•	•	•	•	•	•	•

Note: Also available in Deep Tile and Plain Tile flashing. Contact the Keylite Sales Team regarding these flashing types.



10 year guarantee on Timber Roof Windows.

**Attractive Styling**

The bright white interior finish, painted timber frame is ideal for contemporary interiors. Our streamlined low profile aluminium exterior perfectly matches the modern appearance. Manual and Solar blinds are also available to match any interior.

**Energy Efficient**

This fixed skylight, with a U-Value of 1.4 W/m².K comes with energy efficient 28mm double glazing and our unique Thermal Collar.

**Cost Effective**

Our Fixed Shut Skylight benefits from all of Keylite's innovations, at no extra cost, making it a practical and cost effective choice in certain applications.

A Fixed Shut Skylight is ideal to **flood living spaces with natural light** in circumstances where opening and closing is not required.

Combination Roof Window Options



Create something truly unique

By combining multiple Keylite Roof Windows you can design and create your very own light-filled vista.

The Keylite Sales Team is always available to assist you in specifying the optimum solution for your project and will create an order schedule for combination windows and flashings. Their contact details can be found at the back of the brochure.

To find out more about our Combination Roof Window options visit keylitteroofwindows.com.

Step One

Choose your roof windows

First choose your preferred roof window style - either Centre Pivot, Top Hung or a combination of both. Then select the desired size, finish option and glazing options. Our Centre Pivot Combination Window is **keyliteConnect®** compatible* so opt for either electric opening with Integral Blinds or manual opening and surface blinds.



Step Two

Choose your window layout



Combi System

Side by side on a horizontal plane.

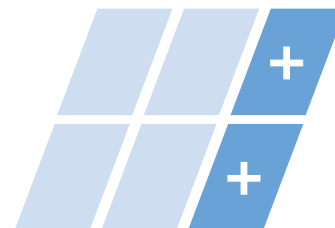

Grid System

Multiple windows in grid formation.

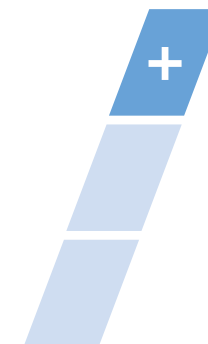

Bi-Lite System

One over the other on a vertical plane.

* Only compatible with **keyliteConnect®** Solar windows.

Step Three

Window spacing

The standard spacing on our Combination Roof Windows is 100mm. We do offer the option of 18mm or 50mm spacing on our Combi System. Contact the Keylite Sales Team regarding the smaller spacing options.

Step Four

Choose your flashing

The choice of flashing depends on the roof finish. We can accommodate almost all types of modern roof finishes. Contact the Keylite Sales Team regarding your flashing requirements.

Step Five

Choose your finish

The finishing touch to your Combination Roof Windows. Choose White or Pine Internal Support Trimmers.

Note: Structural Support Trimmers are compulsory with all 18mm Combination Systems.



By combining multiple
Keylite Roof Windows
you can **design and
create** your very own
light-filled vista.

Vertical Bi-Lite Window System VBL

The Vertical Bi-Lite is a vertical window component, which combines with a Keylite Roof Window to produce an attractive glazing feature. This is a highly effective way to maximise the levels of light and ventilation in any room.

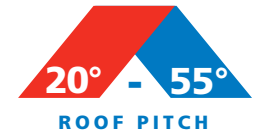

Vertical Bi-Lite Window System VBL

Code	Description		
Size WxH (mm)		780x600	780x950
White Painted Pine			
WFBVL T	 White Finish, Single, Tilt Only	•	•
WFBVL T 2018	 White Finish, Double, Tilt Only	•	•
WFBVL T 3018	 White Finish, Triple, Tilt Only	•	•
WFBVL TT	 White Finish, Single, Tilt and Turn		•
WFBVL TT 2018	 White Finish, Double, Tilt and Turn		•
WFBVL TT 3018	 White Finish, Triple, Tilt and Turn		•

Clear Lacquered Pine is available on request (6 week lead time).

Note: Roof windows not included in system.

For VBL Systems outside the above specification, contact the Keylite Sales Team.

Triple systems in Pine and White have a six week lead time.



Step One

Decide if the system you require is a single, double or triple.

Step Two

Select your roof window(s) in size 04, 05, 06. Decide if you want Centre Pivot or Top Hung, with Clear Lacquered Pine or White Finish. **Note:** Roof windows are not included in system.

Step Three

Select the vertical height of your window. We offer two heights: 600mm or 950mm. Both sizes are available with a Tilt opening method. The 950mm deep window is also available in a Tilt & Turn opening method. This larger size can qualify as a means of escape. Contact the Keylite Sales Team for more information.



Tilt

Window opens on the horizontal plane.



Tilt & Turn

Window can be opened on the horizontal or vertical plane.

Step Four

Flashing is not included with the price of your vertical window so specify your roof finish (slate or tile) and roof pitch. For further assistance contact the Keylite Sales Team.

Note: Roof pitch must be provided when ordering the flashing.

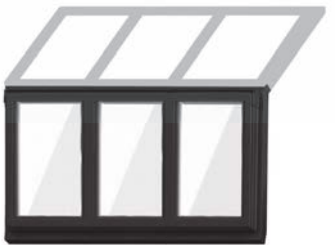

10 year guarantee on Bi-Lite Window Systems.

Ridge Window RG



The Keylite Ridge System may be installed along the roof ridge to maximise light and space at the highest point of the pitched ceiling.



Ridge Window RG

Code	Description	01	02	01C	03	04	05	06	07F	07	08	09	10
Size WxH (mm)		550x780	550x980	550x1180	660x1180	780x980	780x1180	780x1400	940x1400	940x1600	1140x1180	1340x980	1340x1400



Ridge Window

RGSRF	Single Ridge, Slate Flashing		•	•	•	•	•	•	•	•	•	•	•
RGTRF	Single Ridge, Tile Flashing		•	•	•	•	•	•	•	•	•	•	•
CRGSRF	Combi Ridge, Slate Flashing		•	•	•	•	•	•	•	•	•	•	•
CRGTRF	Combi Ridge, Tile Flashing		•	•	•	•	•	•	•	•	•	•	•

Note: The codes above refer to the flashing only for a complete system, a roof window must be specified separately. For further information contact the Keylite Sales Team. Windows that are 280mm or more down from the ridge can be fitted using Standard Keylite Flashings. Windows that are less than 280mm will have to be fitted with the Keylite Ridge Flashings. Please specify roof pitch and roof finish - Tile, Slate or Plain Tile Flashings when placing your order. (Plain Tile = TRF). Also available for Conservation Windows.

RG Features

Suitability

Keylite Ridge Roof Windows are ideal for both domestic and commercial applications, and are available for the following ranges: Centre Pivot, Conservation and Polar White PVC, Pine and White Finish Roof Windows, all with the option of an Integral Blind.

Usually installed in out of reach locations, these roof windows work beautifully with our new keyliteConnect® Solar range, with our Integral Blinds providing control over daylight and ventilation.

Installation

The installation of Keylite Ridge Roof Windows is very similar to standard roof window installation. The roof windows must be positioned as fitting instructions advise to avoid the sashes colliding when opened.



10 year guarantee on Ridge Window Systems.

Sunlite Light Tube System SL

A Keylite Sunlite will transform a dark or windowless room into an area full of natural light and energy. They are a fantastic addition to an area of your home where it hasn't been possible for natural light to get to before. Perfect for bathrooms, stairways or corridors, they channel sunlight from your roof, down a highly reflective tube into the room below.

Why choose a Keylite Sunlite?

A Keylite Sunlite can be installed on a pitched roof or on a flat roof extension to allow daylight to flood the rooms where it's most required.

The Keylite Sunlite itself is available with either rigid or flexi tubing. Both have their own benefits. The descriptions below will help you choose which option is most suitable for your home.

Rigid tubing

Offer better light transmittance than the flexible sun tunnel. Rigid sun tunnels allow for the light to channel down the tube from roof to ceiling in a direct motion. The less the light bounces off the internal surface of the tube, the more natural light you will get in the required room.

Flexi tubing

The flexible tube allows you to negotiate around obstructions in the roof space. Due to the build of the flexible tube, light will reflect less in a flexible sun tunnel, effectively directing the light away from its required destination, resulting in less light reaching the required room. With this in mind, the 2m system still has an 86% light transmittance.

Note: Keylite recommends a minimum 350mm diameter Rigid Light Tube System to achieve the best results (98% reflectance).

Code	Description	250	350	450	530
Size Diameter (mm)					

Pitched Roof Sunlite System

SLRSS	Sunlite Rigid System Slate	•	•	•	•
SLRST	Sunlite Rigid System Tile	•	•	•	•
SLFSS	Sunlite Flexi System Slate		•	•	•
SLFST	Sunlite Flexi System Tile		•	•	•

Note: When placing your order please specify slate or tile flashing. If roof to ceiling distance is more than 2m please add Rigid Extension (below), flexible systems cannot be extended.

Flat Roof Sunlite System

SLRSF	Sunlite Rigid System Flat Roof	•	•	•	•
--------------	--------------------------------	---	---	---	---

Note: Tube length 800mm. If roof to ceiling distance is more than 800mm, please add Rigid Extension.

Sunlite Accessories

SLL	Sunlite Lamp	•	•	•	•
SLRE	Sunlite Rigid Extension Tube 625mm	•	•	•	•

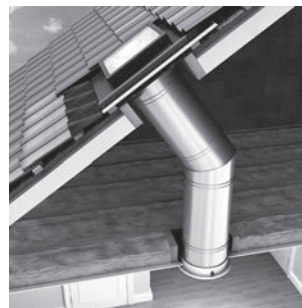

Rigid System

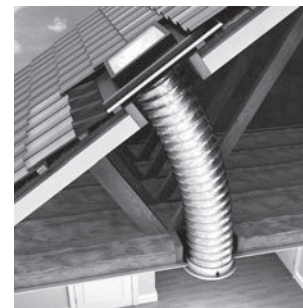

Flexi System



Sunlite Lamp

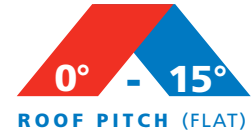

Pitched roof



Flat roof



GUARANTEE

10

10 year guarantee on Sunlites.

Benefits

A Keylite Sunlite saves on energy and transforms dark or windowless rooms. It comes with a double glazed ceiling diffuser that gives a soft light pattern and is finished with a white ceiling trim. Optional integrated fluorescent lamp can be fitted to any Sunlite, reducing the need for additional ceiling fittings.

Rigid System

For optimum performance - Keylite's Rigid Tube System is made using a hard wearing, mirror finished, polished aluminium tube with 98% reflectance. Kit includes a rigid tube 800mm long.

Flexi System

For versatility - recommended for installations where obstructions within the roof prohibit the use of a rigid system. This system offers 86% reflectance.

Recommended Use

250mm Diameter:

Bathroom, WC, small hallway.

350mm Diameter:

Bathroom, en suite, WC, hall, small staircase.

450mm Diameter:

Bathroom, office, hall, corridor.

530mm Diameter:

Living room, office, kitchen, hallway.

Keylite Sunlite Kit

Each Sunlite system comes with the necessary roof flashing and coverings. We also provide a 2m length of either rigid or flexi tubing (rigid recommended) and a white ceiling diffuser. The Keylite Flat Roof Sunlite is supplied with a unique timber insulated upstand as standard to ensure the installation is as simple as possible.

Note: Flat roof Sunlite systems (SLRSF) comes with a tube length of 800mm.

Magnetic fixings allow for quick installation and easy cleaning of the ceiling diffuser. Exterior Self-Cleaning Glass ensures maximum daylight is achieved and is simple to maintain. Ventilated with unique fittings at both roof and ceiling levels, which combat the risk of condensation.

A Keylite Sunlite will transform a dark or windowless room into an area full of natural light and energy.



Without Sunlite



With Sunlite

Smoke Ventilation Roof Windows SVK

The Keylite Smoke Ventilation System integrates seamlessly with a building's main fire alarm interface and is designed to open a Keylite Roof Window automatically, in the event of a fire.

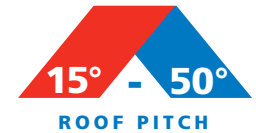

Smoke Ventilation Roof Windows SVK

Code	Description	08	10
Size WxH (mm)		1140x1180	1340x1400
Smoke Ventilation Free Area		1m ²	1.5m ²
SVK	Smoke Ventilation Kit	•	•
WD	Wind Deflector (for compliance with aerodynamic smoke ventilation requirements only)	•	•



SVK Features

Features

The Keylite Smoke Ventilation System integrates seamlessly with a building's main fire alarm interface, or can operate independently as a stand-alone system. Should the building's electrical system fail, have the peace of mind that a 3-day battery back-up power supply is provided with the system as standard.

This system is only available on timber roof windows in two standard sizes: 08 (1m²)* and 10 (1.5m²)*. Other certified sizes are available, contact Keylite Technical for details.

* Smoke Ventilation Area

Fully Tested

For geometric and aerodynamic smoke ventilation requirements, our systems are fully tested and certified to EN12101-2 on roof pitches between 15°- 50°.

This system should be upgraded to comply with aerodynamic smoke ventilation requirements mentioned above by including the optional Wind Deflector (WD) to the SVK.

Contact Keylite Aftersales Support for information on requesting additional functionality inspections.

Kit Includes:

Actuator, Control Panel, Break Glass Unit, Smoke Detector & 3-day battery back-up pack.

Note: Roof window and flashing are not included.



3 year guarantee on electrical components.



By combining multiple
Keylite Roof Windows
it's possible to **create**
something truly
unique for your home.



Flat Roof Solutions



Flat Roof Solutions

Creating the ultimate daylight experience for your flat roof home or extension doesn't need to be difficult. At Keylite we offer a range of roof solutions giving you plenty of options to enhance the look of your home. Our flat roof solutions offer a sleek, modern look along with all the functionality and additional daylighting a roof window has to offer.

Adding a flat roof window makes it effortless to flood natural daylight and fresh air into your flat roof home or extension, converting dull rooms into vibrant living spaces. Whatever your needs there is a flat roof solution designed to suit your requirements. The flat roof windows feature a range of finish options, as well as a variety of high-performance glazing options to maximise energy efficiency.

Roof Lantern

The Keylite Roof Lantern floods in atrium style daylighting with a big view of the sky. It is available up to 6m x 4m for maximum impact on living areas.

Flat Roof System

The Flat Roof System is a kerb arrangement designed to facilitate installation of a single or pair of roof windows on a flat roof. Suitable for corridors and functional spaces.

Flat Roof Sunlite System

Dark hallways and rooms without windows can be lit by natural daylight using our flat roof Sunlite system.





Flat Glass Rooflight

A modern, contemporary design which allows light to flood into the internal areas below. Available fixed shut, or with manual and electrical opening options.

These are just some of the flat roof solutions Keylite offer, the full range can be seen in this brochure.





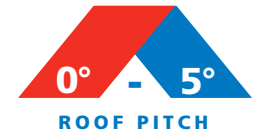

Keylite offer a **variety of flat roof solutions** to help create the ultimate daylighting experience - converting dull rooms into vibrant living spaces.

Roof Lantern FRL

The Keylite Roof Lantern creates the ultimate daylighting experience with the ability to convert dull rooms into vibrant living spaces. Ideal for flat roof extensions, these elegant Roof Lanterns facilitate daylighting on a grand scale.



Roof Lantern FRL

						
Product Code	1510	2010	2015	2515	3015	3020
External Frame Size LxW (mm)	1500x1000	2000x1000	2000x1500	2500x1500	3000x1500	3000x2000
Approx. Height (mm)	358	358	474	474	474	591
FRL	•	•	•	•	•	•

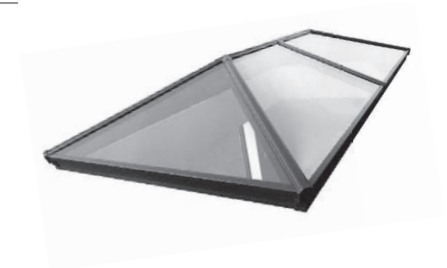

Energy efficiency

The sleek, thermally broken aluminium frame is just 57mm wide, providing a classic appearance to the Roof Lantern.

Every aspect has been designed to maximise energy efficiency in conjunction with the Roof Lantern's high-performance glazing options, delivering excellent U values from 1.0 W/m².K.

Thermal efficiency of the Keylite Roof Lantern has been guaranteed by the elimination of cold bridging, achieved by isolating the external profiles from the internal profiles.

Combined with high performance glazing, the Keylite Roof Lantern's ability to reduce heat transfer is in a class of its own.

Glass performance

	Standard	Optional Upgrades				
Glass Finish	Clear	Blue	Aqua	Privacy	Sunshade Blue	Bronze
U-Value	1.2 W/m ² .K	1.2 W/m ² .K	1.0 W/m ² .K	1.2 W/m ² .K	1.0 W/m ² .K	1.2 W/m ² .K
Solar Heat Reflection	42%	60%	82%	34%	82%	55%
Light Transmission	78%	47%	30%	54%	25%	38%
Self Cleaning	Yes	Yes	Yes	No	Yes	Yes

Note: Colours shown are for visual purposes only and are not an accurate representation of glazing colours.



10 year guarantee on Roof Lanterns.



Performance Glazing

The Keylite Roof Lantern is supplied with a range of high performance glass options.

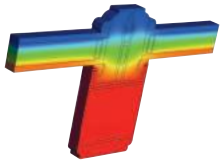

Insulating T-bar

The high quality insulating T-bar bridges the gap between the profiles and the aluminium finishing caps, to create the best possible thermal break.



Thermally Broken Eaves Beam

Eaves beams are fully thermally broken to create an insulated barrier between the aluminium sections.



Perfect for flat roof extensions,
the Keylite Roof Lantern
creates **the ultimate
daylighting experience.**

Flat Roof System FRS



Keylite has developed a Flat Roof System specifically for flat or almost flat roofs that provides all the benefits of natural ventilation and daylight. Every Keylite Roof Window can be integrated within a Flat Roof System.

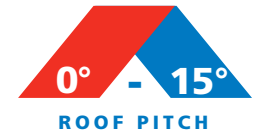

Flat Roof System FRS

Code	Description	01	02	01C	03	04	05	06	07F	07	08	09	10
Size WxH (mm)		550x780	550x980	550x1180	660x1180	780x980	780x1180	780x1400	940x1400	940x1600	1140x1180	1340x980	1340x1400



Flat Roof System

FRS	Flat Roof System with Flashing & Upstand for One Window	01	02	01C	03	04	05	06	07F	07	08	09	10
		•	•	•	•	•	•	•	•	•	•	•	•

Note: The codes above refer to the flashing and upstand only. A roof window must be specified separately. For further information contact the Keylite Sales Team.

FRS Features

Flexibility

The Keylite Flat Roof System is available for the entire Keylite Roof Window range.

Unique Design

In order to maximise the amount of natural light entering the room, the front and back frames of the insulated timber upstand are splayed to outwards.

Operation

Our Flat Roof System can be operated manually or equally with Keylite Electric Operation and Smoke Ventilation Systems. It is also KeyliteConnect[®] compatible.

Installation

Keylite Flat Roof Systems come prefabricated for ease of installation on site and can be installed in a flat roof not exceeding 15°. For the installation of roof windows over 2.2m above the floor, Keylite also recommend an electrical control unit and a laminated inner pane.

Complete Kit

The Keylite Flat Roof System is supplied with a fully insulated timber upstand and all associated Flat Roof System flashings.



10 year guarantee on Flat Roof Systems.

Combination Flat Roof System CFRS



A practical solution to the installation of two or three windows in a flat roof. The system is completely pre-fabricated for ease of installation on-site.



Combination Flat Roof System CFRS

Code	Description	01	02	01C	03	04	05	06	07F	07	08	09	10
Size WxH (mm)		550x780	550x980	550x1180	660x1180	780x980	780x1180	780x1400	940x1400	940x1600	1140x1180	1340x980	1340x1400

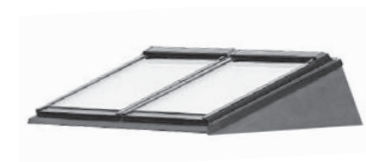

Double Combination Flat Roof System

CFRS 2018	Combination Flat Roof System	•	•	•	•	•	•	•	•	•	•	•	•
-----------	------------------------------	---	---	---	---	---	---	---	---	---	---	---	---

Triple Combination Flat Roof System

CFRS 3018	Combination Flat Roof System	•	•	•	•	•	•	•					
-----------	------------------------------	---	---	---	---	---	---	---	--	--	--	--	--

Note: The codes above refer to the flashing and upstand only. A roof window must be specified separately. For further information contact the Keylite Sales Team.

CFRS Features

Flexibility

The Keylite Flat Roof System is available for the entire Keylite Roof Window range.

Unique Design

In order to maximise the amount of natural light entering the room, the front and back frames of the insulated timber upstand are splayed to outwards.

Operation

Our Flat Roof System can be operated manually or equally with Keylite Electric Operation and Smoke Ventilation Systems. It is also **KeyliteConnect** compatible.

Installation

Keylite Flat Roof Systems come prefabricated for ease of installation on site and can be installed in a flat roof not exceeding 15°. For the installation of roof windows over 2.2m above the floor, Keylite also recommend an electrical control unit and a laminated inner pane.

Complete Kit

The Keylite Flat Roof System is supplied with a fully insulated timber upstand and all the associated Flat Roof System flashings.



10 year guarantee on Flat Roof Systems.

Flat Glass Rooflight FRG

With its anthracite grey frame and double glazed finish, the Keylite Flat Glass Rooflight provides a contemporary alternative to polycarbonate flat roof products. The Keylite Flat Glass Rooflight is available in fixed shut, manual and electrical opening options with a toughened outer pane for maximum durability.

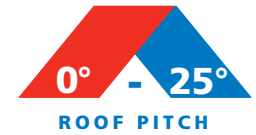

Flat Glass Rooflight FRG

Code	Description	S6	R69	S8	S9	R912	S10	R1015	S12
Size WxH (mm)		600x600	600x900	800x800	900x900	900x1200	1000x1000	1000x1500	1200x1200
Structural Opening Size (mm)		625x625	625x925	825x825	925x925	925x1225	1025x1025	1025x1525	1225x1225

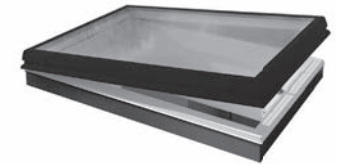

Flat Glass Rooflight

FRG	Flat Glass Rooflight, Fixed Shut	•	•	•	•	•	•	•	•
------------	----------------------------------	---	---	---	---	---	---	---	---

Flat Glass Rooflight - Manual Opening

FRG M	Flat Glass Rooflight, Manual Opening	•	•	•	•	•	•		
--------------	--------------------------------------	---	---	---	---	---	---	--	--

Flat Glass Rooflight - Electric Switch

FRG ES	Flat Glass Rooflight, Electric Operation with Switch	•	•	•	•	•	•		
---------------	--	---	---	---	---	---	---	--	--

Flat Glass Rooflight - Electric Remote

FRG ER	Flat Glass Rooflight, Electric Operation with Rain Sensor & Remote	•	•	•	•	•	•		
---------------	--	---	---	---	---	---	---	--	--

FRG Features

Performance

The Keylite Flat Glass Rooflight is fitted with a double glazed 6mm toughened outer pane and an 8.8mm laminated inner pane. Thermal performance is enhanced with the use of an insulated 150mm PVC upstand giving an overall U-Value of 1.26W/m².K.

CWCT Class 1 non-fragile testing obtained.

Options

Choose from either fixed shut, manual and electric opening options.

Installation

The rooflight is suitable for roof pitches between 5° and 25° but can be installed on roof pitches below 5° when mounted to an additional upstand at 5°.



10 year guarantee on Flat Glass Rooflight.

3 year guarantee on electrical components.

Low Rise Dome KLRD

Keylite Low Rise Domes are thermoformed with a triple skin construction. Polycarbonate is virtually unbreakable, with an impact strength many times greater than glass. Low Rise Domes can be supplied with a clear or opal finish and are available with fixed or electric opening options.

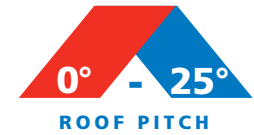

Low Rise Dome KLRD

Code	Description	S6	R69	S75	S9	R912	S105	R105150	S12	S15
Size WxH (mm)		600x600	600x900	750x750	900x900	900x1200	1050x1050	1050x1500	1200x1200	1500x1500
Structural Opening Size (mm)		625x625	625x925	775x775	925x925	925x1225	1075x1075	1075x1525	1225x1225	1525x1525

Fixed Dome

KLRD	Low Rise Dome, Fixed Shut, Clear	•	•	•	•	•	•	•	•	•
KLRD OPAL	Low Rise Dome, Fixed Shut, Opal	•	•	•	•	•	•	•	•	•

Manual Opening Dome

KLRD M	Low Rise Dome, Manual Operation, Clear	•	•	•	•	•	•	•	•	•
KLRD OPAL M	Low Rise Dome, Manual Operation, Opal	•	•	•	•	•	•	•	•	•

Electric Opening Dome (Electric Remote)

KLRD ER	Low Rise Dome, Electric Operation with Remote Control, Clear	•	•	•	•	•	•	•	•	•
KLRD OPAL ER	Low Rise Dome, Electric Operation with Remote Control, Opal	•	•	•	•	•	•	•	•	•

Note: Additional sizes are available upon request. For further information contact the Keylite Sales Team.

KLRD Features

Performance

The Keylite Low Rise Dome has a triple skin polycarbonate top and boasts a U-Value of 1.3W/m².K, which exceeds the thermal requirements of Part L. The dome has sleek, contemporary aesthetics inside and out and an aerodynamic low rise glazing unit.

We provide a 10 year rooflight / 3 year accessories guarantee on this product.

Options

Choose from either clear or opal finish in manual or electric opening. Cabling and actuators are hidden within the kerb on electric opening units. An extended range of ventilation, access and up-stands are available upon request.

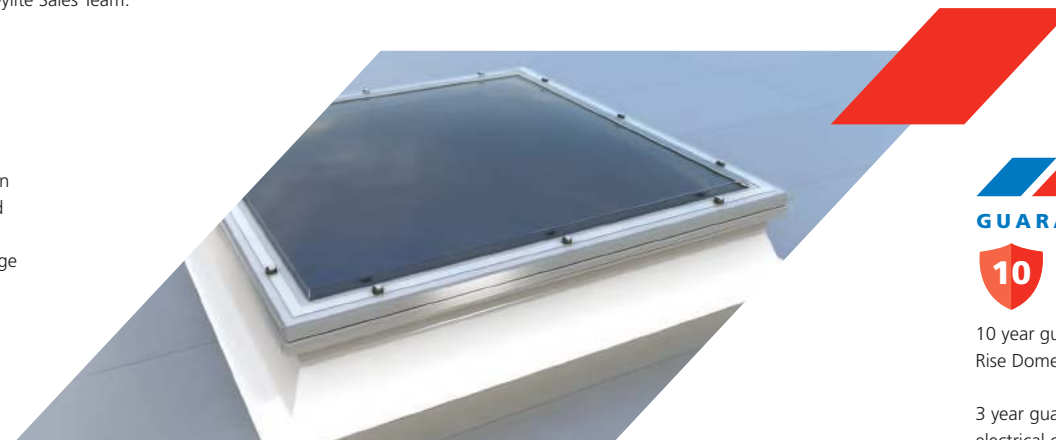

10 year guarantee on Low Rise Dome.

3 year guarantee on electrical components.

Low Rise Access Hatch KLRD AH

A Keylite Low Rise Access Hatch provides safe, easy access to roof areas for maintenance and other utility purposes, and can form part of a fire escape route. Access hatch rooflights feature internal opening mechanisms to facilitate a 90° opening, allowing for a safe route for personnel and equipment.

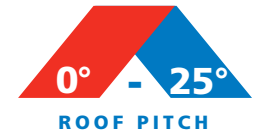

Low Rise Access Hatch KLRD AH

Code	Description	R759	S9	R7512	R912	S105	R105150	S12
Size WxH (mm)		750x900	900x900	750x1200	900x1200	1050x1050	1050x1500	1200x1200
Structural Opening Size (mm)		775x925	925x925	775x1225	925x1225	1075x1075	1075x1525	1225x1225
Access Hatch								
KLRD AH	Low Rise System with Access Hatch Opening, Clear	•	•	•	•	•	•	•
KLRD OPAL AH	Low Rise System with Access Hatch Opening, Opal	•	•	•	•	•	•	•



Note: Additional sizes are available upon request. For further information contact the Keylite Sales Team.

KLRD AH Features

Performance

The Keylite Low Rise Access Hatch has a triple skin polycarbonate top and boasts a U-Value of 1.3W/m².K, which exceeds the thermal requirements of Part L.

The units, with their telescopic gas struts, offer the benefit of a safe access route and excellent insulating value and sound reduction. They are supplied complete and ready to fit.

We provide a 10 year rooflight / 3 year accessories guarantee on this product.

Options

Choose from either clear or opal finish. An extended range of ventilation, access and up-stands are available upon request.



GUARANTEE



10 year guarantee on Low Rise Access Hatch.

3 year guarantee on electrical components.

Low Rise Smoke Ventilation KLRD AOV

Keylite Smoke Ventilaton Domes are electrically operated smoke vents designed to allow the release of smoke from buildings in the case of a fire. This enables the key fire escape routes, such as stairwells and corridors, to be kept visible with minimal smoke build up.



Low Rise Smoke Ventilation KLRD AOV

Code	Description	S105	S12	R1218	S15
Size WxH (mm)		1050x1050	1200x1200	1200x1800	1500x1500
Structural Opening Size (mm)		1075x1075	1225x1225	1225x1825	1525x1525
Ventilation Area (m ²)		0.88m ²	1.0 m ²	1.5 m ²	1.5 m ²
Smoke Ventilators					
KLRD AOV	Low Rise System with Smoke Ventilation, Clear	•	•	•	•
KLRD OPAL AOV	Low Rise System with Smoke Ventilation, Opal	•	•	•	•



Note: Additional sizes are available upon request. For further information contact the Keylite Sales Team.

KLRD AOV Features

Performance

All Keylite Low Rise Smoke Ventilators are fully tested and certified in accordance with EN 12101-2, they meet standards for safety, security, non-fragility and fire safety.

Keylite's Low Rise Smoke Ventilaton Dome comes with a 365mm PVC upstand and opens to 160° within 60 seconds. It's available in a range of sizes.

We provide a 10 year rooflight /3 year accessories guarantee on this product.

Options

The actuator can be off set for access purposes. The ventilator is available in clear and opal glazing and with triple skin for optimal thermal performance and resistance to condensation or double skin options.

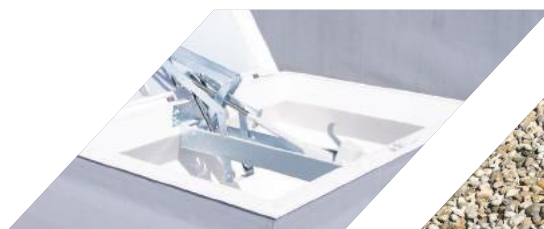

GUARANTEE



10 year guarantee on Low Rise Smoke Ventilator.

3 year guarantee on electrical components.

Roof Window Flashings

Keylite Flashing Kits are the most effective way to ensure a watertight installation for your roof windows and have been designed to integrate efficiently with specific roofing materials.

The installer friendly instructions and one-piece bottom apron ensure easy first time fitting. The unique one-piece bottom apron design improves aesthetic finish and allows for easy installation.

Tile TRF

Roof Pitch 20° - 90°

Material Profile - Max 45mm

Flashing for single window installation into interlocking profiled tiles or interlocking plain tiles.

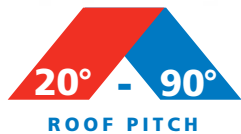

Max. 45mm

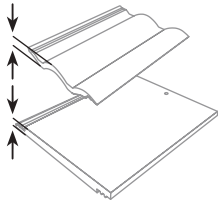

Deep Tile DTRF

Roof Pitch 15° - 90°

Material Profile - Max 90mm

Flashing for single window installation into flat or profiled interlocking tiles. Also suitable for interlocking slate and profiled sheeting.

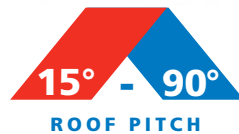

Max. 90mm

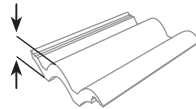

Slate SRF

Roof Pitch 15° - 90°

Material Profile - Max 10mm

Flashing for single window installation into slate up to 10mm thick. **Note:** Not to be used with interlocking slate.

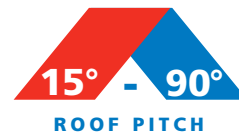

Max. 10mm

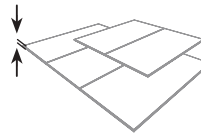

Plain Tile PTRF

Roof Pitch 25° - 90°

Material Profile - Max 15mm

Flashing for single window installation into plain tiles. **Note:** Not to be used with interlocking plain tiles.

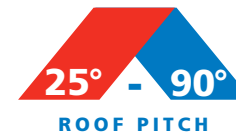

Max. 15mm

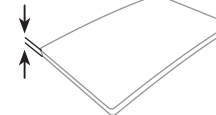

Low Pitched LTRF

Roof Pitch 10° - 20°

Material Profile - Max 90mm

Flashing for single pitched window installation onto a low pitched tile roof.

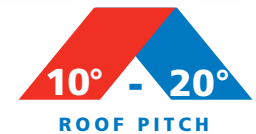

max. 90mm

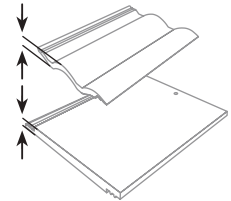

Zinc ZRF

Roof Pitch 15° - 90°

Flashing for single window installation into zinc sheeting. For more information contact the Keylite Sales Team.

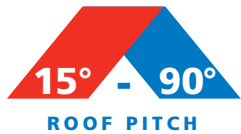

Keylite Flashing Kits are the most effective way to **ensure a watertight installation** for your roof windows.

Single Flashings

The Keylite range of easy fit aluminium flashings is the essential partner to the Keylite Roof Window range.

Single Flashings

Code	Description	01	02	01C	03	04	05	06	07F	07	08	09	10
Size WxH (mm)		550x780	550x980	550x1180	660x1180	780x980	780x1180	780x1400	940x1400	940x1600	1140x1180	1340x980	1340x1400
Single Flashings													
SRF	Slate Max. 10mm profile. Pitch 15°-90°	•	•	•	•	•	•	•	•	•	•	•	•
TRF	Tile Max. 45mm profile. Pitch 20°-90°	•	•	•	•	•	•	•	•	•	•	•	•
DTRF	Deep Tile Max. 90mm profile. Pitch 15°-90°	•	•	•	•	•	•	•	•	•	•	•	•
PTRF	Plain Tile Max. 15mm profile. Pitch 25°-90°	•	•	•	•	•	•	•	•	•	•	•	•
CWSRF	Conservation Slate Max. 10mm profile. Pitch 15°-90°	•	•	•	•	•	•	•	•	•	•	•	•
CWTRF	Conservation Tile Max. 45mm profile. Pitch 20°-90°	•	•	•	•	•	•	•	•	•	•	•	•
CWDTRF	Conservation Deep Tile Max. 90mm profile. Pitch 15°-90°	•	•	•	•	•	•	•	•	•	•	•	•
CWPTRF	Conservation Plain Tile Max. 15mm profile. Pitch 25°-90°	•	•	•	•	•	•	•	•	•	•	•	•
VBLSRF	Vertical Bi-Lite Slate Max. 45mm profile. Pitch 20°-55°	•	•	•	•	•	•	•	•	•	•	•	•
VBLTRF	Vertical Bi-Lite Tile Max. 90mm profile. Pitch 20°-55°	•	•	•	•	•	•	•	•	•	•	•	•
Low Pitch Flashings													
LTRF	Low Pitch Tile. Pitch 10°-20°	•	•	•	•	•	•	•	•	•	•	•	•
Corrugated Flashings													
CRF	Corrugated Roof. Pitch 15°-90°	•	•	•	•	•	•	•	•	•	•	•	•



Flashing Features

The installer friendly instructions and one-piece bottom apron ensure easy first time fitting. Our unique one-piece bottom apron design improves aesthetic finish and allows for easy installation.



10 year guarantee on Flashings.

Combination Flashings

The Keylite range of Combination Flashing Systems allows any of the standard Keylite Roof Windows to be installed in vertical, horizontal or group blocks.

Combination Flashings

Code	Description	01	02	01C	03	04	05	06	07F	07	08	09	10
	Size WxH (mm)	550x780	550x980	550x1180	660x1180	780x980	780x1180	780x1400	940x1400	940x1600	1140x1180	1340x980	1340x1400

Combination Flashings

CSRF	Combi Slate Max. 10mm profile		•	•	•	•	•	•	•	•	•	•	•
CTRF	Combi Tile Max. 90mm profile		•	•	•	•	•	•	•	•	•	•	•
BLSRF	Bi-Lite Slate Max. 10mm profile		•	•	•	•	•	•	•	•	•	•	•
BLTRF	Bi-Lite Tile Max. 90mm profile		•	•	•	•	•	•	•	•	•	•	•
QLSRF	Quad-Lite Slate Max. 10mm profile		•	•	•	•	•	•	•	•	•	•	•
QLTRF	Quad-Lite Tile Max. 90mm profile		•	•	•	•	•	•	•	•	•	•	•
RGSRF	Single Ridge, Slate Max. 10mm profile		•	•	•	•	•	•	•	•	•	•	•
RGTRF	Single Ridge, Tile Max. 90mm profile		•	•	•	•	•	•	•	•	•	•	•
CRGSRF	Combi Ridge, Slate Max. 10mm profile		•	•	•	•	•	•	•	•	•	•	•
CRGTRF	Combi Ridge, Tile Max. 90mm profile		•	•	•	•	•	•	•	•	•	•	•



Combinations

Side by Side Combi.



Over and Under Bi-Lite.



2x2 Square Quad-Lite.



Flashing Features

The standard distance between window frames should equal 100mm.

Variations and specials on request; contact the Keylite Sales Team for more information.



GUARANTEE



10 year guarantee on Flashings.

Loft Ladder KYL

The Keylite Loft Ladder is designed to ensure simple, fast installation. With pre-installed Flick-Fit brackets, allowing installation from below the loft and with a unique detachable ladder which enables a one-person installation, the Keylite Loft Ladder is designed to make your life easier.

Loft Ladder KYL

Code	Description	01	02	03	04	05	06	07	08	09
KYL	Loft Ladder	•	•	•	•	•	•	•	•	•
KYL FRES	Fire Resistant Loft Ladder	•	•	•	•	•	•	•	•	•
A	Ceiling Opening Dimension (mm)	550x1000	550x1200	550x1200	600x1000	600x1200	600x1200	700x1000	700x1200	700x1200
B	Frame External Dimension (mm)	530x940	530x1140	530x1140	580x940	580x1140	580x1140	680 x 940	680 x 1140	680 x 1140
	Number of Ladder Sections	4	3	4	4	3	4	4	3	4
C	Dimension (mm)	1025	1025	1145	1025	1025	1145	1025	1025	1145
D	Dimension (mm)	1300	1565	1605	1300	1565	1605	1300	1565	1605
E	Height (mm)	2800	2800	3200	2800	2800	3200	2800	2800	3200

Convenient

All our Loft Ladders come with Flick-Fit installation - pre-installed brackets that allow for installation from below. In addition, they are supplied with a pre-fitted handrail and our unique detachable ladder which allows for a one person installation.

Performance

Our Loft Ladders have a continuous seal around the trapdoor to reduce heat loss. A white, 36mm thick insulated trapdoor helps to achieve a U-Value of 1.1W/m².K as standard*.

* U-Value determined by calculation

All Keylite loft ladders are draught proof and have obtained the highest air tightness classification possible, Class 4. Security is addressed with a recessed locking system.

Fire Resistant Loft Ladder

Our fire resistant Loft Ladder has a 30 minute fire rating, ideal for meeting specific building regulations.

For further details contact the Keylite Sales Team.

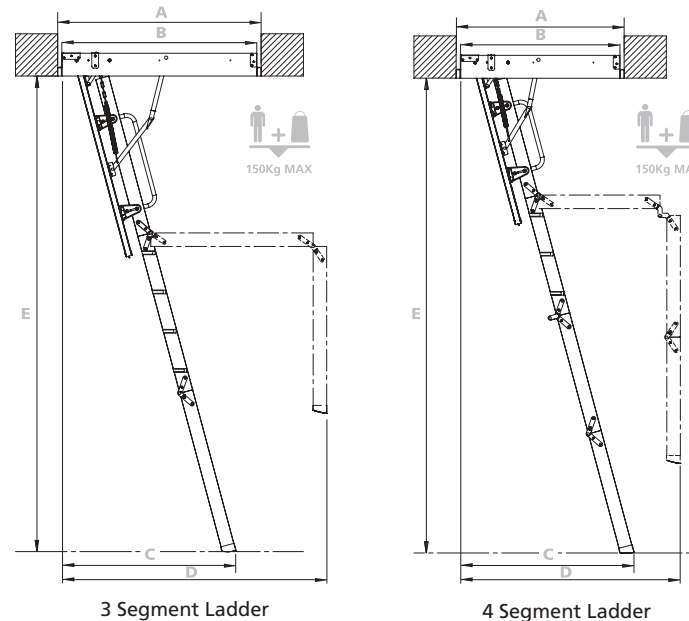

Important Note:
Keylite Loft Ladders are not intended to be used as an alternative and/or substitute for traditional stairs in order to access loft converted areas.



Flick-Fit Installation

Our Loft Ladder comes with pre-installed brackets that allow for installation from below.



Scratch Resistant

Every Keylite Loft Ladder comes with protective feet to help prevent scratching.



Detachable Ladder

This ingenious and unique innovation combined with the Flick-Fit brackets makes it possible for one person to install the Loft Ladder.



Dovetail Joints

To ensure a strong and robust construction we use dovetail joints on all ladder treads.



GUARANTEE



3 year guarantee on Keylite Loft Ladders.

FAST-EASY
ONE PERSON INSTALLATION



Our Loft Ladder is designed to ensure a **simple & fast installation**. A unique detachable ladder enables a one-person installation.



Genuine Keylite Blinds

Choice & style

Create atmosphere with our specially designed Style Collection blinds. Control, block and soften daylight for every mood and every space at home.

Keylite Blinds are used across a diverse range of interiors, whether it is a living room, bedroom, home office, a home gym, or other completely unique space that requires some love and attention. You can make the most of any interior space simply by adding colourful, bright Keylite Blinds from our Style Collection, which brings together a range of colours, patterns and fabric options.

Unique design

Keylite Blinds come with slim aluminium side rails for smooth operation and a clean classic look. This also gives increased natural light when the blinds are open.

Fully enclosed cassette

Protects fabric from discolouration and eliminates light glow around the edge.

Energy efficient

Controls solar heat gain. Thermal benefits reduce heat loss by at least 20% (BBA Tested).

Fabric options

Available in blackout, dimout and moisture resistant fabrics.

Fingertip control

For an easy and smooth operation.

Fully encased side rails

Brush seals provide 100% blackout and improve thermal efficiency.

Surround choice

White Finish Surround - The perfect complement to your White Finish windows. Aluminium Surround - ideal with Pine Windows for a contemporary finish.

Upgrade to solar

Our solar powered and electric blinds are ideal for those out of reach locations controlled from the comfort of your armchair or bed.

Cord free 100% child friendly

Manual operation

Our one touch control allows for effortless positioning of the blind by hand. Simply press the control bar towards the glass to raise or lower the blind.

Electric operation

Our complete range of blinds is available with remote control electric operation. Our electric blinds are **keyliteConnect**® App compatible and ideal for those out of reach roof window positions.

Solar operation

Our complete range of blinds is available with solar control for manually operated windows. Solar powered remote control blinds are available for all those out of reach areas. They are easy to install with no wiring required.

Note: Electric blinds require an electric operated roof window.



3 year guarantee on Blinds.

With Genuine Keylite Blinds you can **control, soften and block daylight** for every mood and every space at home.

Solar Powered Blinds

Order online at keyliteblinds.com

Convenient

This innovative feature puts Keylite right at the forefront of blinds technology and is the simple answer to opening and closing of blinds in areas difficult to access.

The battery pack, the motor for powering the blind, and the roller for holding the blind fabric are contained in a cassette secured to the top of the window sash.

Easy install

The installation process does not involve any wiring or tracking the walls for mains electric.

Free energy

The solar panel is located in the outward facing edge of the cassette and collects energy from the sun, which then provides a trickle charge to the replaceable battery pack.

Control

The solar blind is controlled with a handheld remote which can be programmed to operate single or multiple blinds arrangements.

Essentials Neutral tones to complement most interior spaces



Classic White B01



Antique Cream B02



Fossil Grey B03



Twilight B14

Decor Stylish colours for unique interiors



Pitch Black B55



Silver Shimmer B50



Hazelwood B34



Grey Whisper B09



Green Parrot B44



Luscious Lime B43



Fresh Mint B18



Intense Hazelnut B10



Muted Mocha B35



Chocolate Chip B36



Sandstone B33



Frosted Stone B32



Lemon Zest B12



Daffodil Yellow B37



Cranberry Crunch B40



Ruby Fountain B41



Scooter Red B39



Burnt Orange B38



Mango Fusion B13



Ballet Slipper B42



Holiday Blue B47



Blue Denim B45



Mineral Blue B46



Summer Medley B48



Duck Egg Blue B49

Aqua Moisture resistant PVC fabrics



White B51



Beige B52

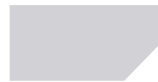

Grey B53



Black B54

Kids Vibrant patterns for fun interiors



Nightfall B06



Puppy Fun B29



Kitten Fun B30



Zoo Time B31

Features



Solar Panel

Located in the outward facing edge of the cassette, the solar panel collects energy from the sun, which then provides a trickle charge to the replaceable battery pack.



Handheld Remote Control

The Solar blind is controlled with a handheld remote which can be programmed to operate single or multiple blinds arrangements.

GUARANTEE

3

3 year guarantee on Blinds.

The solar blind is controlled with a handheld remote which can **operate single or multiple** blinds arrangements.



Thermal Blackout Blinds

Order online at keyliteblinds.com

Thermal Blackout blinds are available with solar, electric or manual operation.

Essential Range

BPS	Manual, Aluminium Surround	•
BPW	Manual, White Surround	•
BPS E	Electric Operated, Aluminium Surround	•
BPS S	Solar Powered, Aluminium Surround	•

Decor & Aqua Range

BPS	Manual, Aluminium Surround	•
BPW	Manual, White Surround	•
BPS E	Electric Operated, Aluminium Surround	•
BPS S	Solar Powered, Aluminium Surround	•

Kids Range

BPS	Manual, Aluminium Surround	•
BPW	Manual, White Surround	•
BPS E	Electric Operated, Aluminium Surround	•
BPS S	Solar Powered, Aluminium Surround	•

To find the blind size of your roof window please see page 76 or contact the Keylite Sales Team for more information.

Note: Electric blinds require an electric roof window.

Essentials Neutral tones to complement most interior spaces

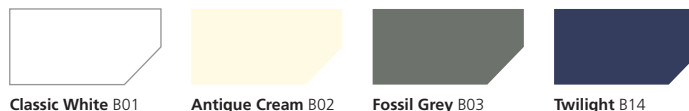

Decor Stylish colours for unique interiors



Aqua Moisture resistant PVC fabrics

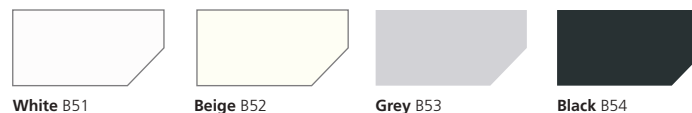

Kids Vibrant patterns for fun interiors



Features



Thermal Benefits

Our Blackout blinds have thermal fabric as standard, for extra cosiness and warmth. Thermal benefits - reducing heat loss by at least 20% (BBA tested).

Total Darkness

Our Blackout range blinds are fitted with side rails so once closed you can enjoy total darkness.

Safety

100% safety focused cordless operation for peace of mind in the home.



GUARANTEE

3

3 year guarantee on Blinds.

Our Thermal Blackout Blinds offer **complete darkness and extra warmth** once closed.

Why Dimout Blinds?

For those who want to transform their home into a place of restful relaxation, then the dimout blind is the perfect choice.

Fully drawn, this blind simply diffuses light to provide a warm and cosy feel, far away from the glare of the world outside, whilst still allowing light to softly permeate through the fabric.

Dimout blinds are available with solar, electric or manual operation.

Essential Range

BPS	Manual, Aluminium Surround	•
BPW	Manual, White Surround	•
BPS E	Electric Operated, Aluminium Surround	•
BPS S	Solar Powered, Aluminium Surround	•

Decor Range

BPS	Manual, Aluminium Surround	•
BPW	Manual, White Surround	•
BPS E	Electric Operated, Aluminium Surround	•
BPS S	Solar Powered, Aluminium Surround	•

To find the blind size of your roof window please see page 76 or contact the Keylite Sales Team for more information.

Note: Electric blinds require an electric roof window.

Essentials Neutral tones to complement most interior spaces



Classic White B01

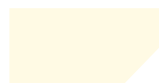

Antique Cream B02



Fossil Grey B03



Twilight B14

Decor Stylish colours for unique interiors



Pitch Black B55



Intense Hazelnut B10



Grey Whisper B09



Lemon Zest B12



Sandstone B33

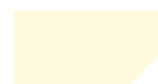

Frosted Stone B32



Fresh Mint B18



Cranberry Crunch B40



Ruby Fountain B41



Blue Denim B45



Mango Fusion B13



Features



Thermal Benefits

Roller cover prevents fading of coloured fabrics.

Safety

100% safety focused cordless operation for peace of mind in the home.



3 year guarantee on blinds.

Our Dimout blind diffuses daylight **to provide a warm and cosy feel** while allowing light to softly permeate through the fabric.

How to order

Follow the simple steps below to order your Genuine Keylite Blinds.

Step One

Choose your style and colour

Select your style from either Blackout, Dimout or Moisture Resistant blinds. Then select your preferred colour from our range of stylish colours and neutral tones to complement your interior space.

To help you decide, Keylite will happily send you a free sample swatch pack to help you make up your mind. The swatch pack can be ordered online at keyliteblinds.com and you can select up to three material samples. If you are still undecided, simply go back to keyliteblinds.com, have another browse and we'll gladly send you an additional swatch pack.



Step Two

Identify the window size and serial number

Your window ID card is located on the top of the window sash and can be viewed when the window is opened.

Look for the Window Size on the ID card - this will give you the size of your roof window. Alternatively, make a note of the Serial Code as either can be used to buy your Keylite blind.



ID Card Location

Locate the Window/Product Size (e.g. T04) or the Serial Code (e.g. 1606170005310) on the silver identification card, located on the top of the window sash. Alternatively you can visit keyliteblinds.com and use your mobile device to scan the ID card.

Important Note:

Blinds for Polar White PVC Roof Windows will have a prefix 'P' in the window size reference. Blinds for timber roof windows* will have a prefix 'T' in the window size reference.

* Blinds are also available for timber roof windows purchased prior to 1st April 2019. These codes do not include the prefix 'T' before the number i.e. T04 = 04. To find the product code on your roof window **see step 2** above or contact the Keylite Sales Team for more information.

Step Three

Operation Choice

Select your method of opening from either:

- Solar
- Electric
- Manual

Step Four

Surround Choice

Select your surround finish from either:

- **White Finish Surround**
The perfect complement to your white windows.
- **Aluminium Surround**
Ideal with Pine Windows for a contemporary finish.

Contacts

Order online

keyliteblinds.com

Email enquires

sales@keyliteblinds.com

Order hotline

GB: +44 (0) 1283 200 197

NI & ROI: +44 (0)28 8676 7515



GUARANTEE



3 year guarantee on Blinds.



We will happily send you a **free sample swatch pack** to help you decide on the colour of your blind.

Accessories

Keylite Accessories enhance your roof window by improving ease of use, safety and help with product maintenance.



Transform the way you experience natural light and ventilation in your home with the **keyliteConnect**® Hub and App - the smart solution for automated control of **keyliteConnect**® compatible roof windows and blinds.

Ease of install

The straightforward set-up procedure within the app will guide you through the process, including pairing windows and assigning groups with personalised names to suit your own individual operational needs. You can easily integrate your app enabled Keylite Roof Windows and blinds to the app, with our quick onboarding process.



Learn more

To find out more see page 14. To order online visit keylitteroofwindows.com/hub

Please note: **keyliteConnect**® App requires a **keyliteConnect**® Hub to work. Only compatible with **keyliteConnect**® Solar Powered Roof Windows.



Upgrade Kits

Electric operation

PEK

Electric Kit

Includes motor, control panel, rain sensor and remote control.

SEK

Keylite Switch Kit

Includes motor and wall mounted transformer switch.

Solar operation

KCS

keyliteConnect® Solar Kit

Includes motor, control panel, battery pack, solar panel, rain sensor and remote control.

Opening Poles



Window Opening Pole

Open your overhead roof window with ease. Suitable for Centre Pivot. Available in 2m and 3m lengths.



Bottom Handle Opening Pole

Open your overhead roof window with ease. Suitable for any roof window with a bottom handle. Available in 2m and 3m lengths.



Security Lock

Additional locking system for enhanced security and peace of mind.

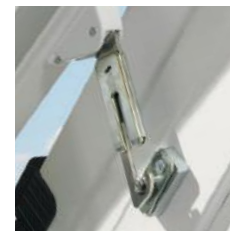

Opening Restrictor

Limits the overall opening of a Centre Pivot Roof Window. Not suitable for escape windows.

Order online at keyliteblinds.com or at your local Merchant.



Roof Window Support Trims

Keylite Roof Window Support Trims are designed to offer increased structural support, and provide an enhanced aesthetic appearance to roof windows that are installed side by side.

Available in a choice of Pine or White, our support trims provide the perfect interior finish.

Maintenance Kits



To help keep your Keylite Roof Window in perfect working condition we offer a range of product specific maintenance kits. These include:

- Polar White PVC Maintenance Kit**
- Pine Maintenance Kit**
- White Painted Maintenance Kit**

Note: The contents of the kit vary depending on the type of window.

Order maintenance kits online at [keyliteroofwindows.com](https://www.keyliteroofwindows.com) or at your local Merchant.

Keylite Accessories enhance your roof window by improving ease of use, safety and help with product maintenance.

Be Inspired

See Keylite's products brought to life in a variety of different settings. Updated regularly with the latest projects using Keylite products, visit keyliteroofwindows.com/casestudies.

Experience how Keylite Roof Windows have helped transform a range of developments, self builds and commercial projects.



Experience how developments, self builds and commercial projects have been **brought to life using natural light and air solutions** from Keylite.

Window Sizes and Product Codes

The Keylite Roof Window range is available in both standard and non-standard sizes. This matrix can be used to establish the size and type of roof windows available.

- PCP** Keylite Polar White PVC, Centre Pivot
- PCP I** Keylite Polar White PVC, Centre Pivot with Integral Blind
- PFE** Keylite Polar White PVC, Fire Escape
- PFE I** Keylite Polar White PVC, Fire Escape with Integral Blind

- WCP** White Painted Pine, Centre Pivot
- WCP I** White Painted Pine, Centre Pivot with Integral Blind
- WFE** White Painted Pine, Fire Escape
- WFE I** White Painted Pine, Fire Escape with Integral Blind

- TCP** Clear Lacquered Pine, Centre Pivot
- TCP I** Clear Lacquered Pine, Centre Pivot with Integral Blind

- TFE** Clear Lacquered Pine, Fire Escape
- TFE I** Clear Lacquered Pine, Fire Escape with Integral Blind

- CW PCP*** Conservation Window, Keylite Polar White PVC, Centre Pivot
- CW PTH*** Conservation Window, Keylite Polar White PVC, Top Hung
- CW WCP*** Conservation Window, White Painted Pine, Centre Pivot
- CW WTH*** Conservation Window, White Painted Pine, Top Hung
- CW TCP*** Conservation Window, Clear Lacquered Pine, Centre Pivot
- CW TTH*** Conservation Window, Clear Lacquered Pine, Top Hung

- SKF** Fixed Shut Skylight

*Available with Integral Blind

° Due to opening size an 02/03B roof window must not be used as a means of escape - Code for 02/03B roof window is 'TH'.

All Polar White PVC windows in 1400mm (H) and/or 1340mm (W) include bottom handle(s).

† 1 bottom handle.
 †† 2 bottom handles.

Contact the Keylite Sales Team for specification.

		Window Width (mm)					
		550	660	780	940	1140	1340
Window Height (mm)	780	01 PCP CW PCP PCP I CW WCP WCP CW TCP WCP I SKF TCP TCP I	03A PCP CW PCP PCP I CW WCP WCP CW TCP WCP I SKF TCP TCP I	04A PCP CW PCP PCP I CW WCP WCP CW TCP WCP I SKF TCP TCP I	07A PCP CW PCP PCP I CW WCP WCP CW TCP WCP I SKF TCP TCP I	08A PCP CW PCP PCP I CW WCP WCP CW TCP WCP I SKF TCP TCP I	09A^{††} PCP CW PCP PCP I CW WCP WCP CW TCP WCP I SKF TCP TCP I
	980	02° PCP TTH PCP I TTH I PTH CW PCP PTH I CW PTH WCP CW WCP WCP I CW WTH WTH CW TCP WTH I CW TTH TCP SKF TCP I	03B° PCP TTH PCP I TTH I PTH CW PCP PTH I CW PTH WCP CW WCP WCP I CW WTH WTH CW TCP WTH I CW TTH TCP SKF TCP I	04 PCP TFE PCP I TFE I PFE CW PCP PFE I CW PFE WCP CW WCP WCP I CW WFE WFE CW TCP WFE I CW TFE TCP SKF TCP I	07B PCP TFE PCP I TFE I PFE CW PCP PFE I CW PFE WCP CW WCP WCP I CW WFE WFE CW TCP WFE I CW TFE TCP SKF TCP I	08B PCP TFE PCP I TFE I PFE CW PCP PFE I CW PFE WCP CW WCP WCP I CW WFE WFE CW TCP WFE I CW TFE TCP SKF TCP I	09^{††} PCP TFE PCP I TFE I PFE CW PCP PFE I CW PFE WCP CW WCP WCP I CW WFE WFE CW TCP WFE I CW TFE TCP SKF TCP I
	1180	01C PCP TFE PCP I TFE I PFE CW PCP PFE I CW PFE WCP CW WCP WCP I CW WFE WFE CW TCP WFE I CW TFE TCP SKF TCP I	03 PCP TFE PCP I TFE I PFE CW PCP PFE I CW PFE WCP CW WCP WCP I CW WFE WFE CW TCP WFE I CW TFE TCP SKF TCP I	05 PCP TFE PCP I TFE I PFE CW PCP PFE I CW PFE WCP CW WCP WCP I CW WFE WFE CW TCP WFE I CW TFE TCP SKF TCP I	07C PCP TFE PCP I TFE I PFE CW PCP PFE I CW PFE WCP CW WCP WCP I CW WFE WFE CW TCP WFE I CW TFE TCP SKF TCP I	08 PCP TFE PCP I TFE I PFE CW PCP PFE I CW PFE WCP CW WCP WCP I CW WFE WFE CW TCP WFE I CW TFE TCP SKF TCP I	09C^{††} PCP TFE PCP I TFE I PFE CW PCP PFE I CW PFE WCP CW WCP WCP I CW WFE WFE CW TCP WFE I CW TFE TCP SKF TCP I
	1400	01F[†] PCP TFE PCP I TFE I PFE CW PCP PFE I CW PFE WCP CW WCP WCP I CW WFE WFE CW TCP WFE I CW TFE TCP SKF TCP I	03F[†] PCP TFE PCP I TFE I PFE CW PCP PFE I CW PFE WCP CW WCP WCP I CW WFE WFE CW TCP WFE I CW TFE TCP SKF TCP I	06[†] PCP TFE PCP I TFE I PFE CW PCP PFE I CW PFE GPFE CW WCP GPFE I CW WFE WCP CW WCP WCP I CW WFE WFE CW TCP WFE I CW TFE TCP SKF TCP I	07F[†] PCP TFE PCP I TFE I PFE CW PCP PFE I CW PFE GPFE CW WCP GPFE I CW WFE WCP CW WCP WCP I CW WFE WFE CW TCP WFE I CW TFE TCP SKF TCP I	08F^{††} PCP TFE PCP I TFE I PFE CW PCP PFE I CW PFE GPFE CW WCP GPFE I CW WFE WCP CW WCP WCP I CW WFE WFE CW TCP WFE I CW TFE TCP SKF TCP I	10^{††} PCP CW PCP WCP CW WCP CP CW TCP SKF
	1600	01G WCP CW WCP WCP I CW WFE WFE CW TCP WFE I CW TFE TCP SKF TCP I TFE TFE I	03G WCP CW WCP WCP I CW WFE WFE CW TCP WFE I CW TFE TCP SKF TCP I TFE TFE I	04G WCP CW WCP WCP I CW WFE WFE CW TCP WFE I CW TFE TCP SKF TCP I TFE TFE I	07 WCP CW WCP WCP I CW WFE WFE CW TCP WFE I CW TFE TCP SKF TCP I TFE TFE I	08G WCP CW WCP WCP I CW WFE WFE CW TCP WFE I CW TFE TCP SKF TCP I TFE TFE I	09G WCP CW WCP TCP CW TCP SKF

Standard Sizes

Non-Standard Sizes

Note: Expect a longer lead time if ordering non-standard sizes.



keyliteroofwindows.com

GB

Unit 3 Gateway Road, Burton Gateway,
Burton upon Trent, DE13 8FL

T: +44 (0) 1283 200 158
E: info@keyliteuk.com

NI & ROI

Derryloran Industrial Est. Sandholes Road,
Cookstown, Co. Tyrone, BT80 9LU

T: +44 (0) 28 8675 8921
E: info@keylite.co.uk

