



millboard

Live. Life. Outside.



DuoSpan™
& DuoLift™

Contents

DuoSpan	Introduction	4
	Applications	6
	Features	13
	Layout and components	14
	Installation	18
	Components	20
	Accessories and fixings	21
<hr/>		
DuoLift	Introduction	8
	DuoLift unpacked	10
	Height chart	11
	Frame compatibility	11
	Layout and components	14
	Installation	18
<hr/>		
Additional information	Testimonials	22
	Technical details	23

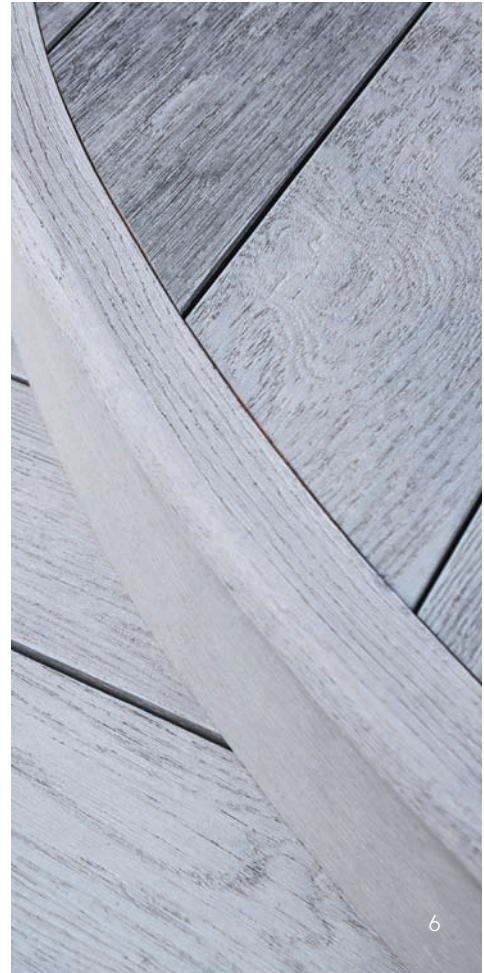
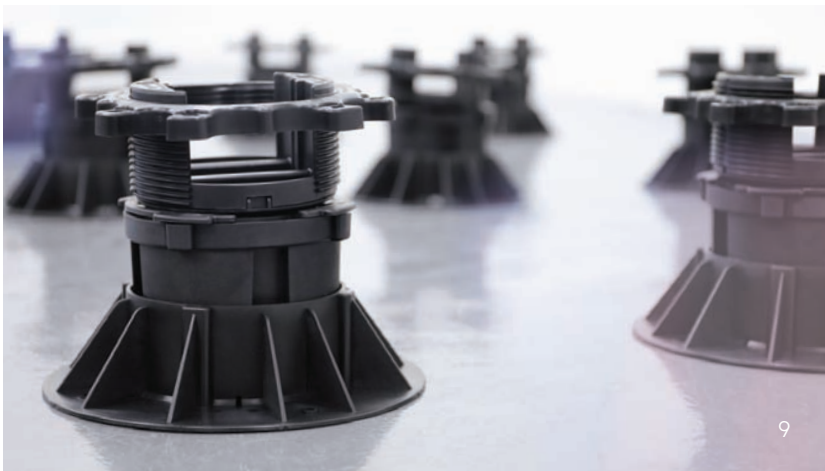



Supporting the best outdoor spaces

The Millboard brand has become synonymous with stunning decks that provide durable distinction in the most stylish outdoor environments.

The finest decks need a support system to match, whatever the underlying substrate. A system that enables innovative and distinctive designs and endures beyond the life of the deck.

That's why we developed our revolutionary DuoSpan support frame and DuoLift joist support system. Because perfect decks should be perfect right through.



The DuoSpan system works seamlessly with DuoLift components. Read more on page 8





DuoSpan™

Adaptable landscape construction



Engineered strength and design versatility

DuoSpan is a unique landscape construction frame, combining the strength of aluminium with the design flexibility of recycled plastic. This combination enables distinctive design opportunities for decking and outdoor structures that would be impossible with conventional subframes.

DuoSpan provides the perfect subframe for Millboard decking, as well as a universal support system for other outdoor flooring. Its ingenious design facilitates top-down fixing of decking boards and also makes it an easy installation for all levels of competence.

DuoSpan has been designed by industry professionals to comply with Eurocode 1: Actions on Structures (BS EN 1991-1-1). The system has been assessed for point loading in relation to both domestic and commercial use, making it suitable for a range of applications.

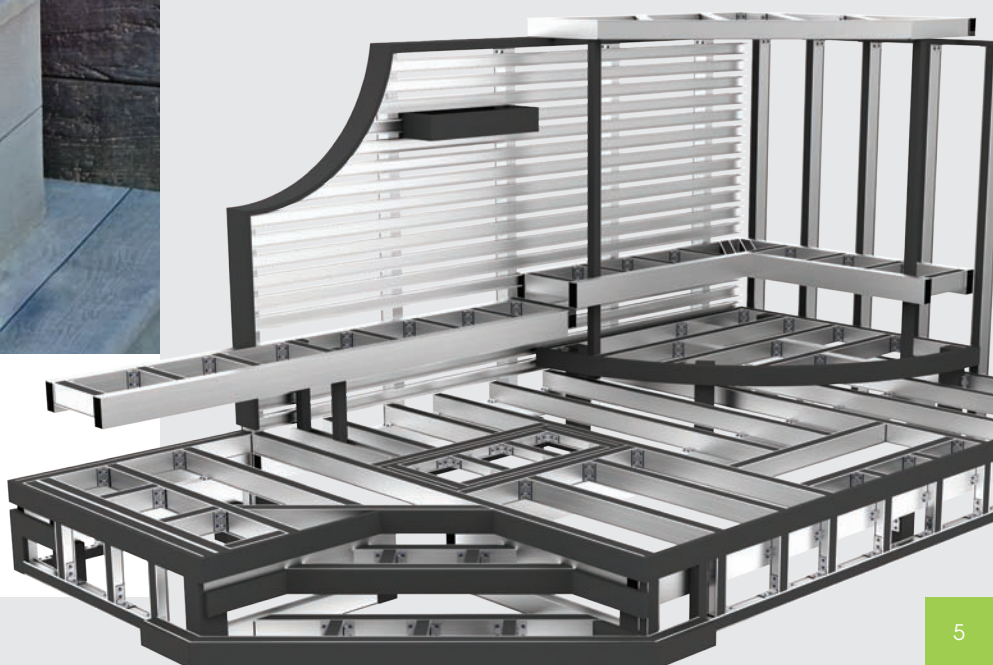

A framework like no other. A subframe and more. Solid straights and stylish curves. Uprights and horizontals.

Making distinctive design possible

Curves

Mind bending possibilities

Flexible supports enable striking and innovative designs.



Steps

Incorporate changes in level

Engineered stability and design flexibility for external steps.



Seating

Strength you can depend on

Durable framework joists allow cantilever structures.



Screening

Create perfect, structural wind breaks

Design your space with zoning and privacy screening.

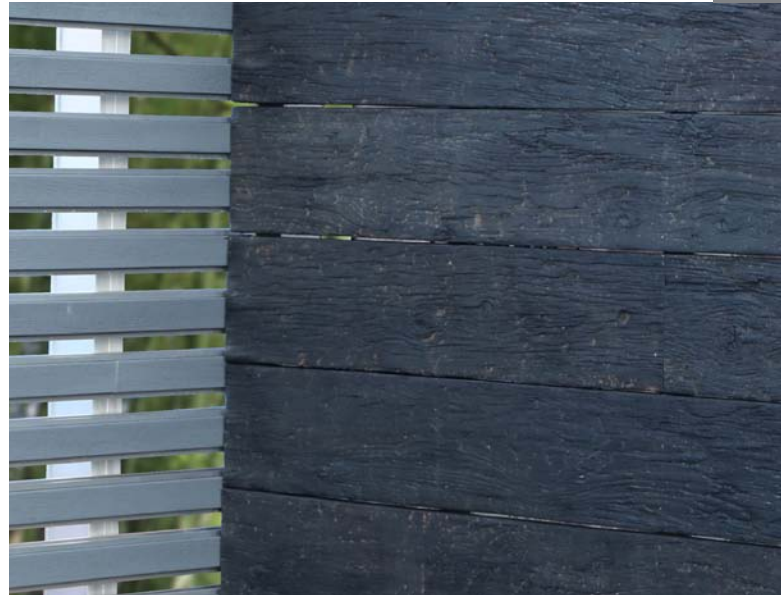

Planters

Make space for nature's beauty

Choice of materials enables creative design features.



Access hatches

Incorporate functionality in style

Adaptable construction supports ingenious features.





DuoLift™

Subframe support that just works

The versatile and user-friendly subframe support system

The DuoLift joist support system was designed to make installation significantly easier and to ensure successful outcomes. Providing substantial height flexibility within four stackable components, DuoLift removes the common problem of having to order varying height pedestals for a single area.

Height-adjustable from 15mm, DuoLift makes accurate height-setting easy, and is self-levelling from 35mm upwards.

DuoLift is the installer's dream.



Structural stability and precision height adjustment. The simple twist-lock support system that makes solid sense.



DuoLift™

DuoLift has been developed by Millboard based on intimate knowledge of the challenges of installing decking on hard surfaces, and the shortcomings of conventional pedestal/cradle systems. It removes the arbitrary choice of pedestal heights, and instead provides a 15-60mm Joist Cradle with a sequence of support components that can raise the height to a maximum of 350mm.

Making installation easy

Every aspect of the installer's experience has been considered, and fine details of the design make height adjustment easier and give confidence when installing. The larger 114mm diameter of the Joist Cradle and the 220mm diameter of the Foot provide more effective load spreading.

Twist-lock system

To ensure the best solid fit, the DuoLift boasts the twist-lock system, rather than a loose stacking.

DuoLift unpacked

DuoLift Joist Cradle 15-60mm

10 pack: PMCP010

Providing an exceptional height range of 45mm, from 15-60mm, the DuoLift Joist Cradle enables precision height adjustment with 5mm markings on the side and each quarter turn of the adjustment ring representing a 1mm rise or fall. The Joist Cradle allows the installer to adjust the height whilst the joist is in place, locking tabs provide a secure finish once correct height has been determined.

DuoLift Self-Levelling Joint 20mm

10 pack: PMLP010

Adding 20mm to the height of the supports, the DuoLift Self-Levelling Joint provides easy and effective levelling of a subframe up to 5°, ready for decking installation. Suitable for standing directly onto a solid substrate, or for providing a joint for a higher support.

DuoLift Riser 45mm

10 pack: PMRP010

The Riser component of the DuoLift system increases the height in increments of 45mm. It is capable of sitting directly onto a solid substrate under the Joist Cradle and Self-Levelling Joint or forming part of a higher stack with a foot beneath.

DuoLift Foot 45mm

10 pack: PMFP010

The DuoLift Foot provides a very stable footing for more elevated subframes, raising the height by 45mm and spreading the load further across the substrate, due to the 220mm base supporting a maximum combined height of 350mm.

DuoLift Acoustic Separation Pad 3mm

10 pack: PMAP010

Agglomerated cork and recycled rubber pads offer a layer of protection between joist supports and membranes, as well as providing an acoustic benefit.



Clicks into place



Twist-lock



Twist-lock



Simple stackability for height flexibility

Multiple height combinations from four sturdy components.
With a selection of components on site, installation delays can be avoided.

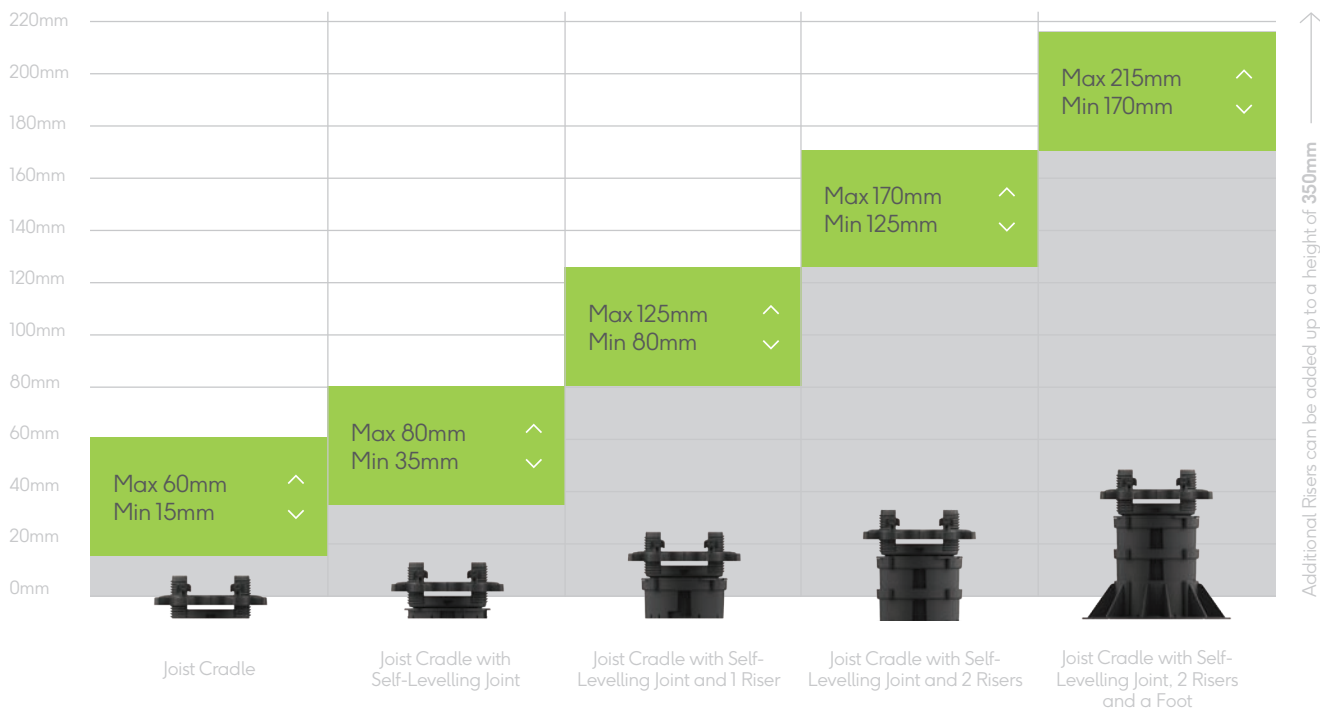

Universal support for all frame types

DuoLift is designed to support a range of joists from DuoSpan to Plas-Pro to timber.



Side tabs twist over the bottom lip of DuoSpan or align with solid joists for a screw fixing.



Straightforward installation

See pages 18-19 for detail

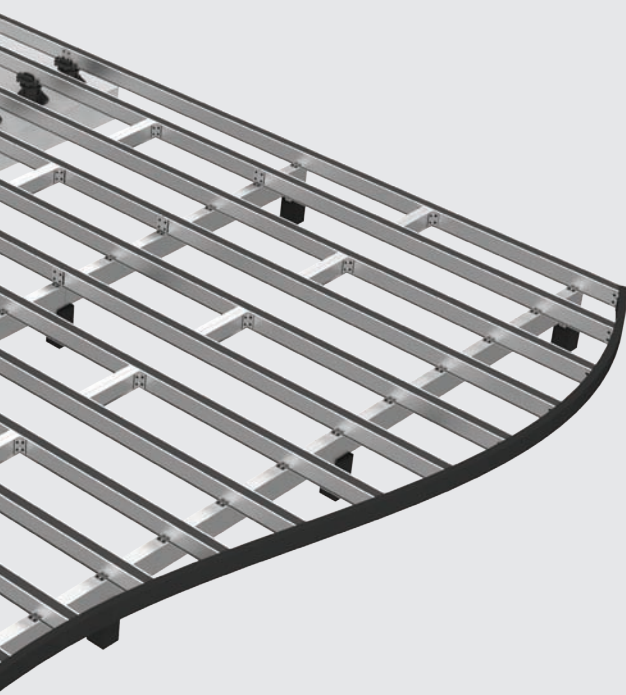

Installing at ground level

When installing a deck on earth or other soft substrate, sturdy Plas-Pro Posts are sunk into the ground to support the framework.

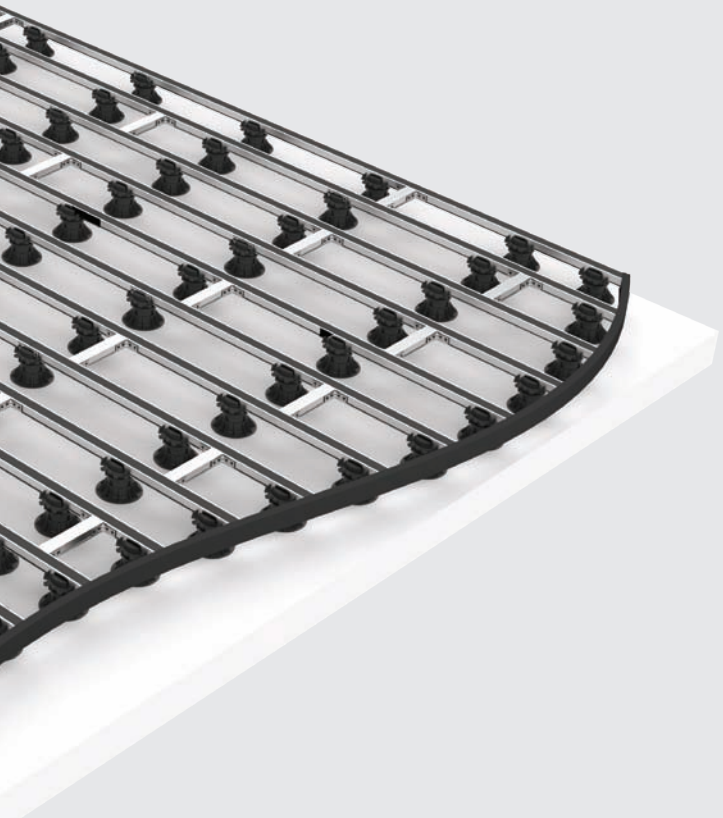

Installing on solid surfaces

When installing on solid/stable surfaces, such as a paved patio or roof terrace, DuoLift provides a perfect support system for the framework.

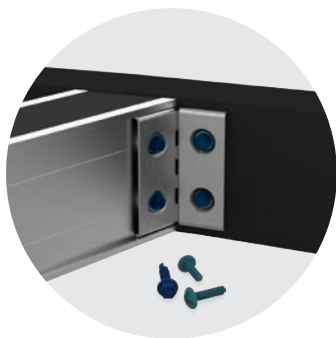

Flexible connectivity

Multiple bracket types facilitate all types of joints, including Flexible Brackets for non-standard angles.

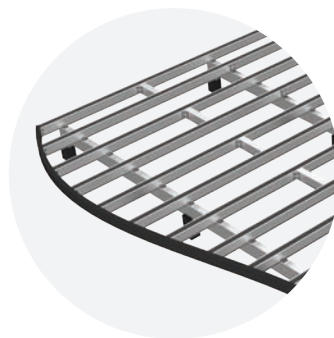

Unique curved constructions

The combination of rigid DuoSpan with flexible Plas-Pro enables the construction of stunning curved formations.



Slot-and-screw assembly

Screw-locating grooves and self-drilling screws ensure accurate alignment and a fast fix that's right first time.

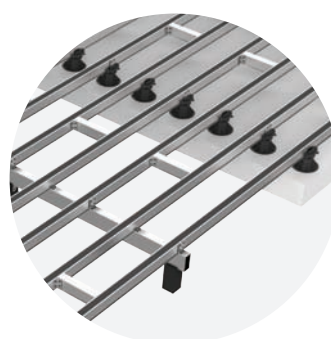

Exceptional spans

The DuoSpan 99mm Joist provides an exceptional 1800mm span in residential applications, reducing posts or joist supports required.



Corrosion-resistant

Galvanic corrosion between different metals is minimised with our cathodic barrier fixings.

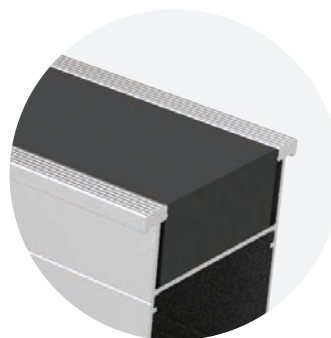

Simple, stable fixing

Decking and cladding can be easily and securely screwed directly into the DuoSpan Joist Insert at almost any angle using Durafix 45mm screws.

Layout and components

DuoSpan 51mm Joists and DuoLift joist supports

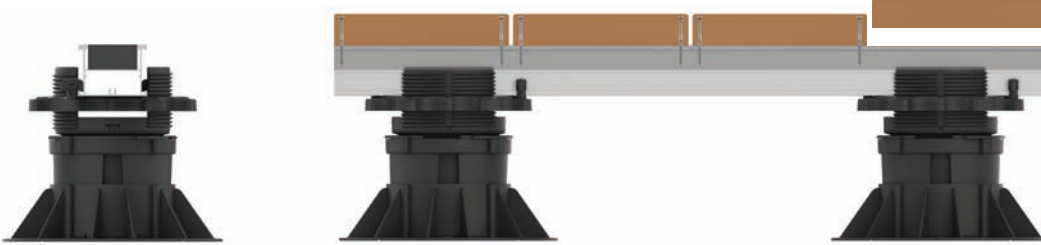

Durafix 4.5 x 45mm Screw
FT45P250 (box of 250)

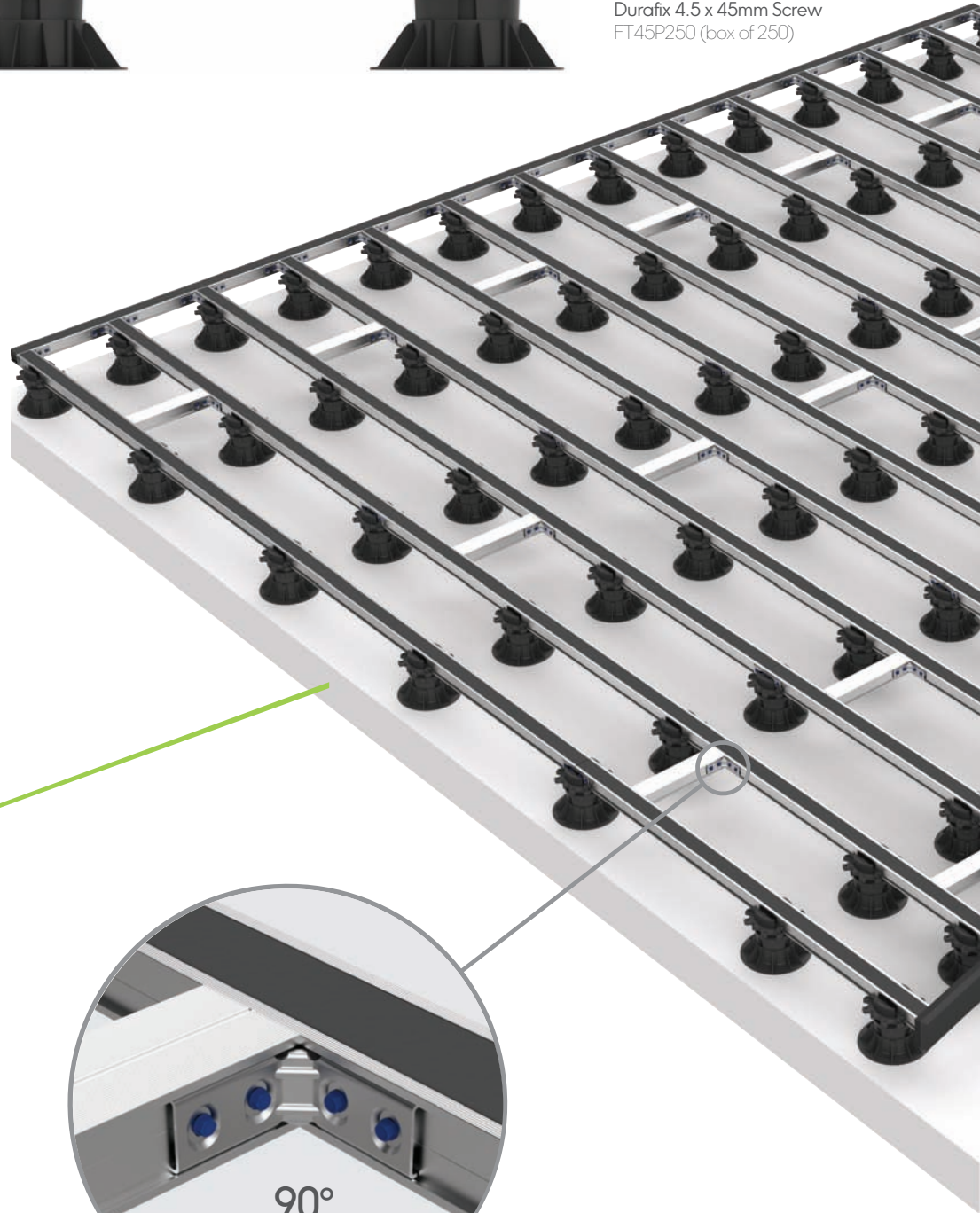

Solid surface installation

DuoSpan 51mm Joists with DuoLift joist supports



DuoSpan 51 90° Angle Bracket
K51RP010 (box of 10, incl. fixings)

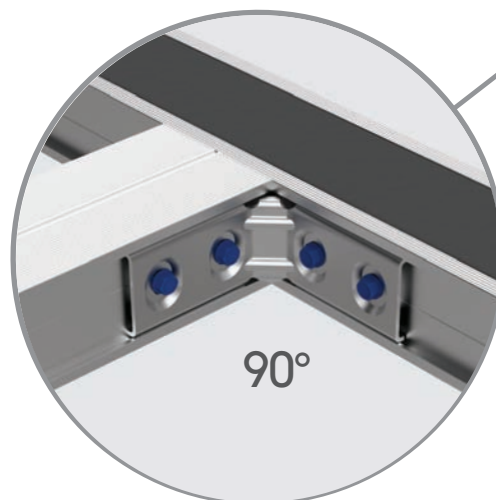



x4

DuoSpan 51 Straight Connector
K51LP010 (box of 10, incl fixings)

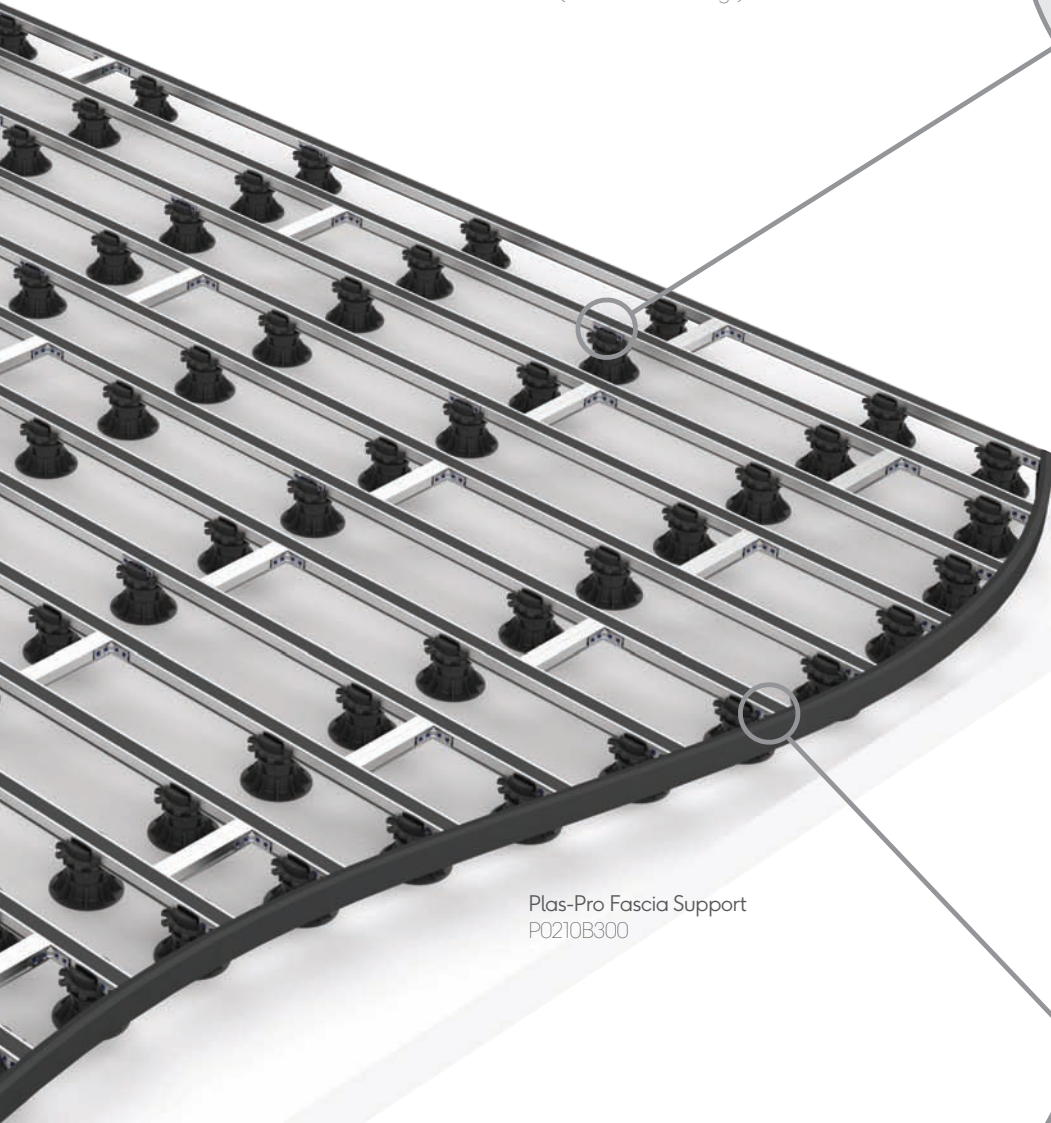

Plas-Pro Fascia Support
P0210B300

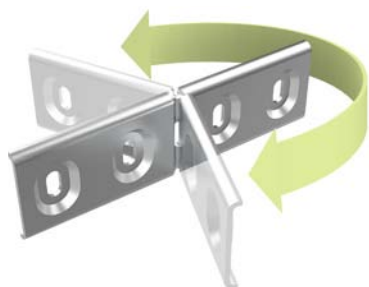

x2



x2

DuoSpan 51 Flexible Bracket
K51FP010 (box of 10, incl fixings)

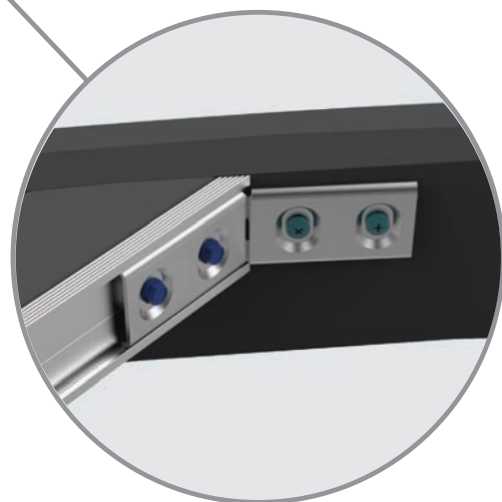

Layout and components

DuoSpan 99mm Joists, DuoSpan 136mm Beams and DuoLift joist supports

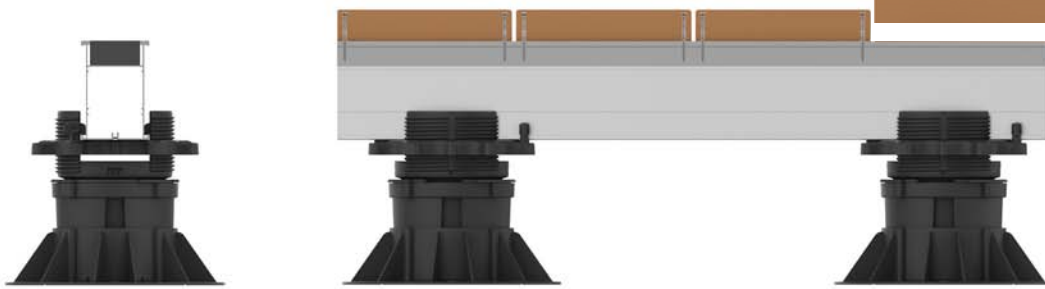

Durafix 4.5 x 45mm Screw
FT45P250 (box of 250)

Solid surface installation

DuoSpan 99mm Joists with DuoLift joist supports

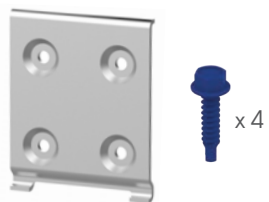
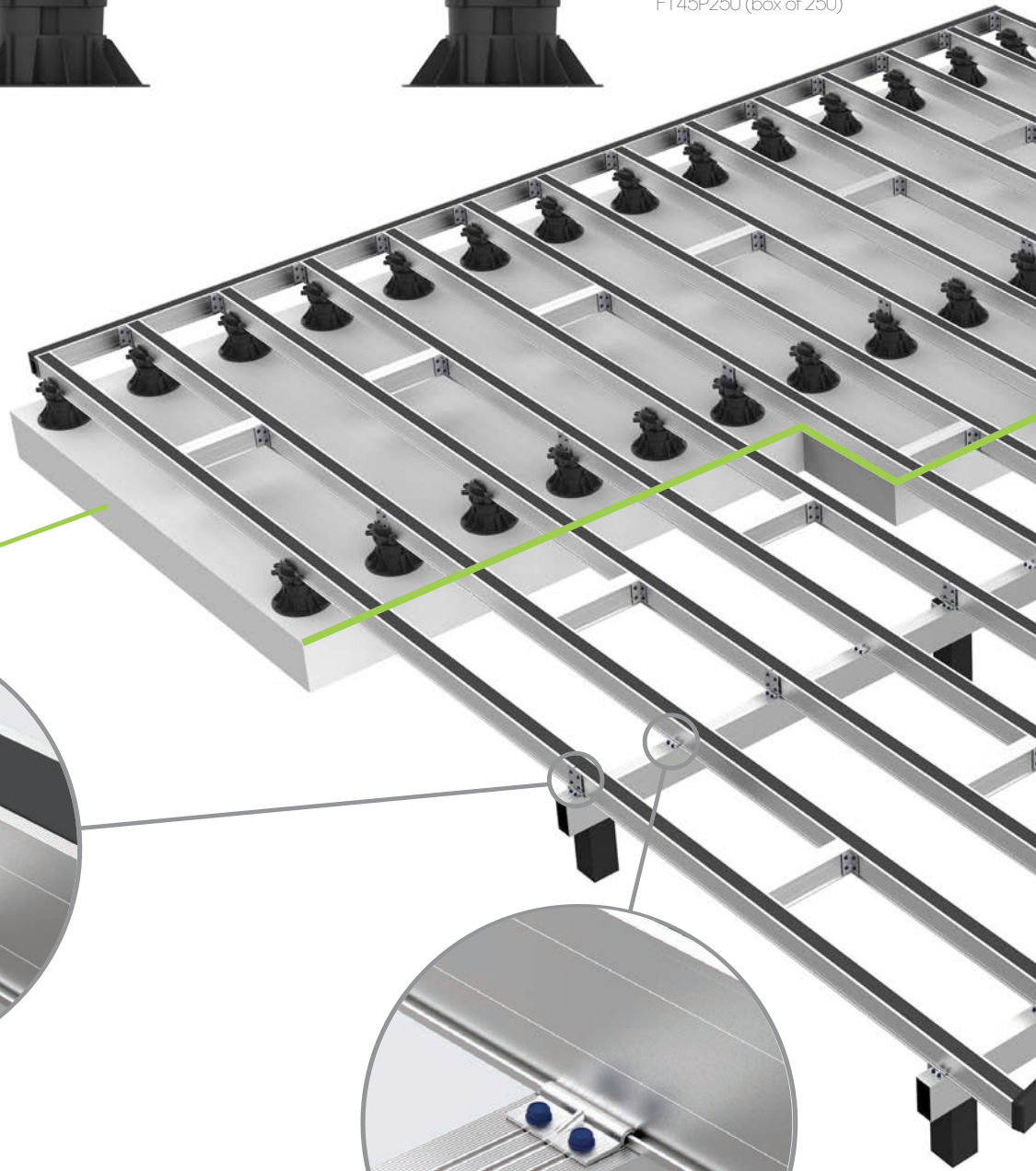

DuoSpan 99 Straight Connector
K99LP010 (box of 10, incl. fixings)

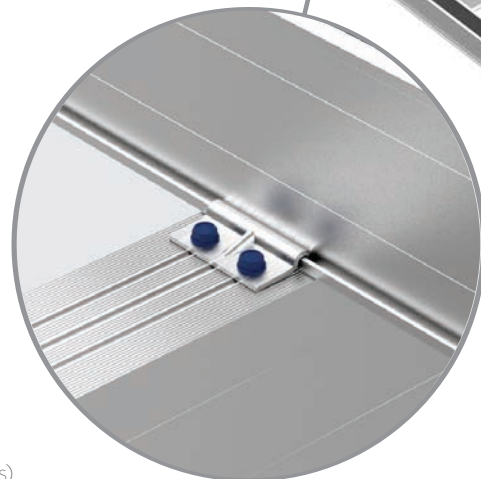

DuoSpan Hold-down Clip
K48CP030 (box of 30, incl. fixings)

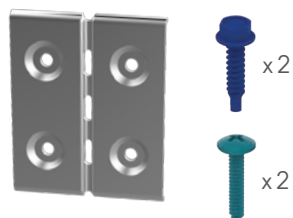

DuoSpan 99 Flexible Bracket
K99FP010 (box of 10, incl. fixings)

Ground level installation

DuoSpan 99mm Joists with DuoSpan 136mm Beams

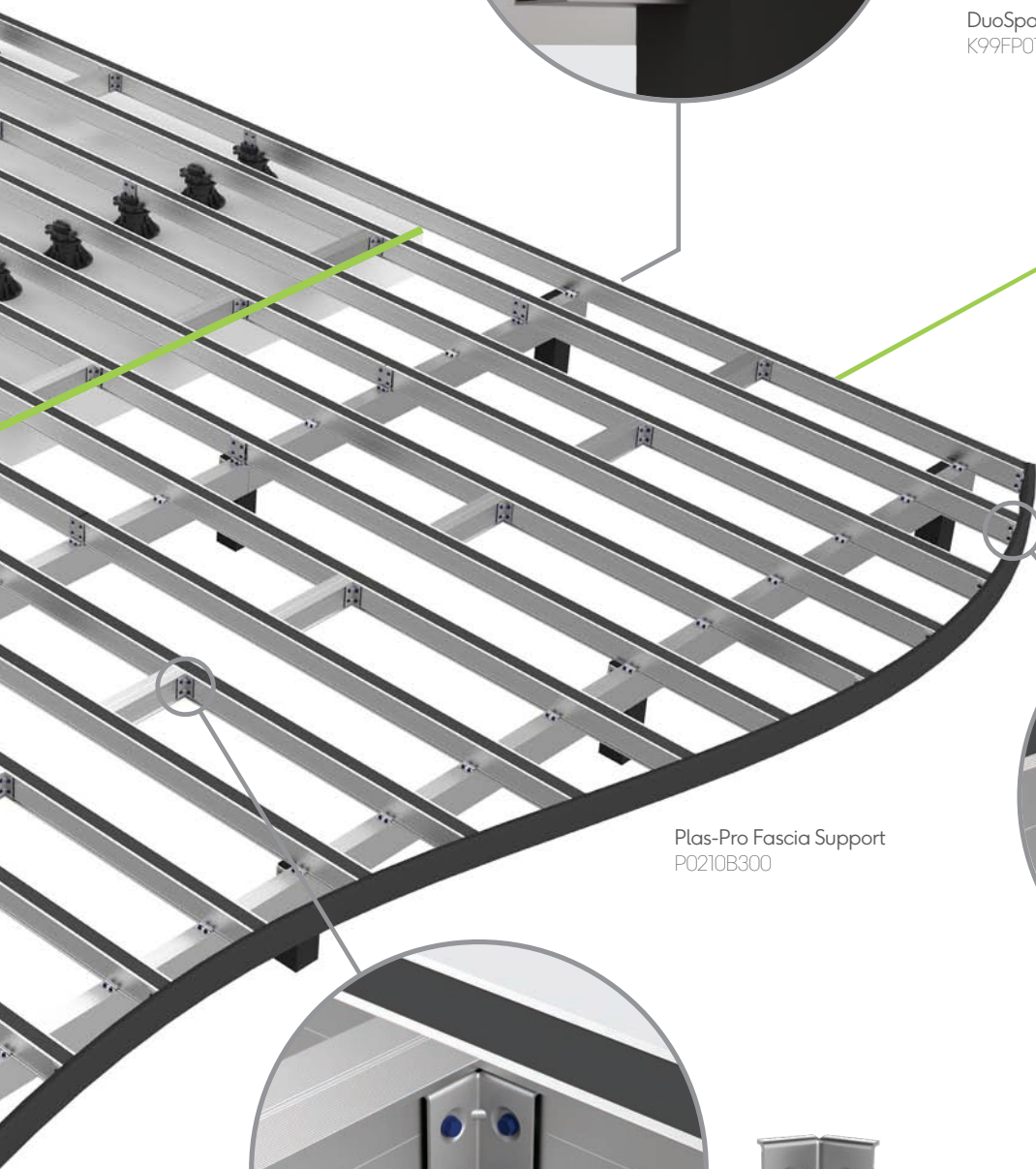

Plas-Pro Fascia Support
P0210B300

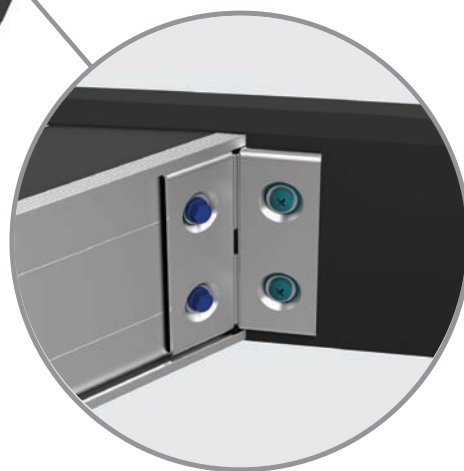

90°



DuoSpan 99 90° Angle Bracket
K99RP010 (box of 10, incl. fixings)

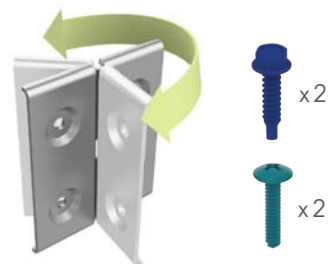

DuoSpan 99 Flexible Bracket
K99FP010 (box of 10, incl. fixings)

Installing at ground level

When installing a deck on earth or other soft substrate, sturdy Plas-Pro Posts are sunk into the ground to support the DuoSpan framework.

Step 1 Prepare ground

Lay the ground sheet, keeping in mind where steps, cladding or furniture will be added. Mark out where the Posts will be installed – 1800mm centres for domestic applications. For commercial applications, please refer to our full installation guide* for more information.



Step 2 Set Posts

Dig holes and concrete the Posts into the ground – two thirds above and one third or 400mm (whichever is greater) below.



Step 3 Install Beams

Notch the top of the Plas-Pro Posts to fit the DuoSpan Beams. Affix the Beams to the Posts using DuoSpan 99 Flexible Brackets on each side. All Beams should finish flush.



Step 4 Affix Joists

Fit the DuoSpan 99mm Joists perpendicularly onto the Beams using DuoSpan Hold-down clips. Set the Joists at 400mm centres for residential applications. For commercial applications please refer to our full installation guide*. Install noggins halfway along Joists at alternate Joist centres and affix with DuoSpan 99 90° Angle Brackets.



Step 5 Add curved features

If the design incorporates a curve, Plas-Pro Fascia Supports can be used to create it. Joists can be cut to shape where required and affixed to the back of the Fascia supports using DuoSpan 99 Flexible Brackets. Edging and fascia boards can later be fitted to the front sides using Durafix 35mm fixings.



Step 6 Add DuoSpan Joist Inserts

Use a rubber mallet to slot the DuoSpan Joist Inserts into the DuoSpan Joists, with the tapered part of the Joist Insert at the bottom. This creates a flush surface, enabling decking or cladding to be screwed into the Joist Inserts with ease using Durafix 45mm fixings.



DuoSpan 51mm Joists are not designed to be used over the DuoSpan 136mm Beams. DuoSpan Joists and Beams can be cut to size with a standard mitre saw fitted with an aluminium-cutting blade. Cut edges of aluminium can be sharp. Always follow the instructions when using power tools and wear appropriate PPE.

*For the full installation guide, visit: www.millboard.co.uk/duospan.

Installing on solid surfaces

When installing on solid/stable surfaces, such as a paved patio or roof terrace, DuoLift provides a perfect support system for the framework.

Step 1 Mark out positions of joist supports

Measure the area, allowing for steps, cladding or other furniture that will be added. Mark out DuoLift joist support locations, based on joist spacing of 400mm centres, and joist support spacing along the joists of 900mm centres on the DuoSpan 51mm Joist, or 1800mm centres on the DuoSpan 99mm Joist. These spacings are for domestic applications. For commercial applications, please refer to our full installation guide, available on the link at the bottom of the page. Consider point loading on roof terrace installations, and set DuoLift Acoustic Separation Pads under DuoLift Joist Supports to protect the membrane.



Step 2 Set and adjust joist supports

Place the DuoLift joist supports at the marked locations. The initial height can be set by turning the height adjustment ring around the Joist Cradle, with each quarter turn adjusting the height by 1mm. The markings at the side of the Joist Cradle denote a 5mm height difference.



Step 3 Install Joists

Place the DuoSpan Joists into the top of the Joist Cradles and turn the adjustment ring around the Joist Cradles to ensure the joist is fully supported. With the Joist in place, locking tabs should be inserted into the adjustment ring on either side of the Joist.

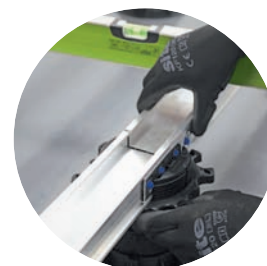

Step 4 Add noggins

Noggins should be inserted into the framework construction, halfway along DuoSpan Joists at alternate Joist centres. Fix them securely in place with DuoSpan 90° Angle Brackets on each side of the Joist.



Step 5 Add curved features

If the design incorporates a curve, Plas-Pro Fascia Supports can be used to create the curve. Joists can be cut to shape where required and affixed to the back of the Fascia Supports using DuoSpan Flexible Brackets. Edging and fascia boards can later be fitted to the front sides using Durafix 35mm fixings.

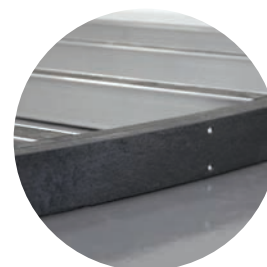

Step 6 Add DuoSpan Joist Inserts

Use a rubber mallet to slot the DuoSpan Joist Inserts into the DuoSpan Joists, with the tapered part of the Joist Insert at the bottom. This creates a flush surface, enabling decking or cladding to be screwed into the Joist Insert with ease. At this point, you may wish to secure the DuoLift joist supports into the ground. Do not fix the DuoLift down if the fixing would pierce the membrane beneath. Ensure Durafix 45mm fixings are used for boards and Durafix 35mm fixings are used for fascia.



DuoSpan Joists can be cut to size with a standard mitre saw fitted with an aluminium-cutting blade. Cut edges of aluminium can be sharp. Always follow the instructions when using power tools and wear appropriate PPE. ***For the full installation guide, visit: www.millboard.co.uk/duolift.**

DuoLift

DuoLift unpacked

Contents	Box Quantity	Heights	Material	Box code
A DuoLift Joist Cradle	10	15 - 60mm	Glass filled nylon	PMCP010
B DuoLift Self-Levelling Joint	10	20mm	Glass filled nylon	PMLP010
C DuoLift Riser	10	45mm	Glass filled nylon	PMRP010
D DuoLift Foot	10	45mm	Glass filled nylon	PMFP010
E DuoLift Acoustic Separation Pad	10	3mm	Agglomerated cork & rubber	PMAP010



A



B



C



D



E

DuoSpan

DuoSpan profiles

Contents	Dimensions	Material	Code
F DuoSpan 51mm Joist	51 x 68 x 3600mm	Aluminium	K5168J360
G DuoSpan 99mm Joist	99 x 68 x 3600mm	Aluminium	K9968J360
H DuoSpan 136mm Beam	136 x 63 x 3600mm	Aluminium	K1363B360



F



G



H



I

DuoSpan insert

Contents	Dimensions	Material	Code
I DuoSpan Joist Insert	25 x 50 x 3000mm	Recycled plastic	K0205B300

Plas-Pro

Contents	Dimensions	Material	Code
J Plas-Pro Fascia Support	100 x 25 x 3000mm	Recycled plastic	P0210B300
K Plas-Pro Post	100 x 100 x 3000mm	Recycled plastic	P1010B300



J



K

Accessories and fixings

Joist bracket sets for DuoSpan 51mm Joist

Contents	Quantity	Dimensions	Material	Box code
DuoSpan 51 90° Angle Bracket	10	–	Aluminium	K51RP010
DuoSpan Hex-head Screw	42	5.5 x 25mm	Cathodic barrier coated s/s	
DuoSpan 51 Flexible Bracket	10	–	Aluminium	K51FP010
DuoSpan Hex-head Screw	42	5.5 x 25mm	Cathodic barrier coated s/s	
DuoSpan Pan-head Screw	20	5 x 25mm	Cathodic barrier coated s/s	
DuoSpan 51 Straight Connector	10	–	Aluminium	K51LP010
DuoSpan Hex-head Screw	42	5.5 x 25mm	Cathodic barrier coated s/s	



Joist bracket sets for DuoSpan 99mm Joist

Contents	Quantity	Dimensions	Material	Box code
DuoSpan 99 90° Angle Bracket	10	–	Aluminium	K99RP010
DuoSpan Hex-head Screw	42	5.5 x 25mm	Cathodic barrier coated s/s	
DuoSpan 99 Flexible Bracket	10	–	Aluminium	K99FP010
DuoSpan Hex-head Screw	42	5.5 x 25mm	Cathodic barrier coated s/s	
DuoSpan Pan-head Screw	20	5 x 25mm	Cathodic barrier coated s/s	
DuoSpan 99 Straight Connector	10	–	Aluminium	K99LP010
DuoSpan Hex-head Screw	42	5.5 x 25mm	Cathodic barrier coated s/s	

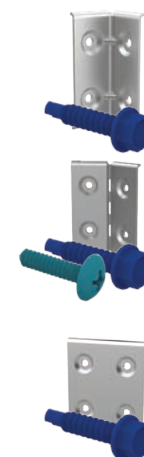

Hold-down clip

Contents	Quantity	Dimensions	Material	Box code
DuoSpan Hold-down Clip	30	–	Aluminium	K48CP030
DuoSpan Hex-head Screw	63	5.5 x 25mm	Cathodic barrier coated s/s	



Plas-Pro profile fixings

Contents	Quantity	Dimensions	Material	Box code
DuoSpan Bracket to Plas-Pro Screw	100	5 x 25mm	Cathodic barrier coated s/s	FD25P100
Plas-Pro to DuoSpan Screw	100	5 x 50mm	Cathodic barrier coated s/s	FD50P100

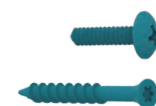

Testimonials

Real reviews from experienced installers

Find a stockist or an
approved installer at:
millboard.co.uk/locator

"I love DuoSpan. It's so different to everything else out there and reduces stress massively."

"It's such a complete system, I don't need anything else."

"Clients prefer this to wood. Far less hassle and maintenance."

"I'm amazed by how quick it is to put together - and so simple too!"

"An excellent solution. It's stable, technically advanced and superior in every way."

"It's so light to work with but is so strong once installed. It's great for Health and Safety sensitive builds too."



DuoSpan Aluminium Profiles

Product		51mm Joist	99mm Joist	136mm Beam
Material		Aluminium alloy 6063		
Profile size	Height	51mm	99mm	136mm
	Width	68mm	68mm	63mm
	Length	3600mm		
Weight per length		4.1kg	5.4kg	7.9kg
Temper		T66		
Finish		Mill		
Extrusion standard		EN 755-9		
Max. recommended unsupported joist span (Domestic applications)		900mm*	1800mm*	1800mm*
Max. recommended unsupported joist span (Commercial applications)		510mm*	1350mm*	1350mm*
Point load deflection criteria		1/250	1/360	1/360
Thermal Expansion		0.0235mm/m/°C		

*Recommended – Refer to loading tables for accurate results based on point loading and UDL criteria as well as cantilever spans.

DuoSpan Joist Insert

Material	Recycled Plastic (Polypropylene & Polyethylene)
Profile	25 x 50 x 3000mm (approx. size)
Weight	3.7kg
Finish	Black
Thermal Expansion	0.1899 mm/m/°C
Screw Pull Out	7.5kN

DuoLift Joist Supports

Material	30% Glass Filled Nylon 6
15-60mm Joist cradle diameter	114mm
45mm foot base diameter	220mm
Height range	15-350mm*
Working temperature	-30°C to +120°C
Biological/Chemical	Resistant to moulds, algae, alkali, bitumen, UV
Flammability	UL94 Class HB
Loading Capacity	5kN
Factor of Safety	1.4-1.9

*Refer to page 11 for accurate height specifications.

millboard.co.uk

© 2020 The Millboard Company Ltd. Millboard®, Lastane®, Durafix®, Lasta-Grip®, DuoSpan®, DuoLift® and the phrase "Live. Life. Outside.™" are protected trademarks. Patents and Patents Pending apply to Millboard® products. The company will vigorously defend its patent rights. Due to printing restraints, actual colours may vary from those shown in brochure. This brochure is not to be reproduced or copied without written permission from Millboard directors. Millboard has a policy of continual improvement to specification. Product blend, colours and sizes may change without notice. All sizes and measurements are nominal. Information is correct at time of going to press. Patent numbers include GB 2445714, GB 2449184, USA 8,065,849, CAN 2664329, EU 1951971.

The Millboard Company Ltd
UK Head Office
Unit A, Castle Court
Bodmin Road
Coventry CV2 5DB

T +44 (0) 24 7643 9943
F +44 (0) 24 7661 1668
E enquiries@millboard.co.uk

Company registered No. 06061318
VAT No: 980 616602

